

PRELIMINARY

**NEC** www.DataSheet4U.com NEC LCD Technologies, Ltd.

# TFT COLOR LCD MODULE

## NL6448BC18-03F

15 cm (5.7 Type)  
VGA

### PRELIMINARY DATA SHEET

DOD-PP-0563 (1st edition)

**All information is subject to change without notice.  
Please confirm the sales representative before  
starting to design your system.**

# PRELIMINARY

## INTRODUCTION

The Copyright to this document belongs to NEC LCD Technologies, Ltd. (hereinafter called "NEC"). No part of this document will be used, reproduced or copied without prior written consent of NEC.

NEC does and will not assume any liability for infringement of patents, copyrights or other intellectual property rights of any third party arising out of or in connection with application of the products described herein except for that directly attributable to mechanisms and workmanship thereof. No license, express or implied, is granted under any patent, copyright or other intellectual property right of NEC.

Some electronic parts/components would fail or malfunction at a certain rate. In spite of every effort to enhance reliability of products by NEC, the possibility of failures and malfunction might not be avoided entirely. To prevent the risks of damage to death, human bodily injury or other property arising out thereof or in connection therewith, each customer is required to take sufficient measures in its safety designs and plans including, but not limited to, redundant system, fire-containment and anti-failure.

The products are classified into three quality grades: "**Standard**", "**Special**", and "**Specific**" of the highest grade of a quality assurance program at the choice of a customer. Each quality grade is designed for applications described below. Any customer who intends to use a product for application other than that of Standard quality grade is required to contact an NEC sales representative in advance.

The **Standard** quality grade applies to the products developed, designed and manufactured in accordance with the NEC standard quality assurance program, which are designed for such application as any failure or malfunction of the products (sets) or parts/components incorporated therein a customer uses are, directly or indirectly, free of any damage to death, human bodily injury or other property, like general electronic devices.

Examples: Computers, office automation equipment, communications equipment, test and measurement equipment, audio and visual equipment, home electronic appliances, machine tools, personal electronic equipment, industrial robots, etc.

The **Special** quality grade applies to the products developed, designed and manufactured in accordance with an NEC quality assurance program stricter than the standard one, which are designed for such application as any failure or malfunction of the products (sets) or parts/components incorporated therein a customer uses might directly cause any damage to death, human bodily injury or other property, or such application under more severe condition than that defined in the Standard quality grade without such direct damage.

Examples: Control systems for transportation equipment (automobiles, trains, ships, etc.), traffic control systems, anti-disaster systems, anti-crime systems, medical equipment not specifically designed for life support, safety equipment, etc.

The **Specific** quality grade applies to the products developed, designed and manufactured in accordance with the standards or quality assurance program designated by a customer who requires an extremely higher level of reliability and quality for such products.

Examples: Military systems, aircraft control equipment, aerospace equipment, nuclear reactor control systems, medical equipment/devices/systems for life support, etc.

The quality grade of this product is the "**Standard**" unless otherwise specified in this document.

# PRELIMINARY

## CONTENTS

<b>INTRODUCTION .....</b>	<b>2</b>
<b>1. OUTLINE.....</b>	<b>4</b>
1.1 STRUCTURE AND PRINCIPLE .....	4
1.2 APPLICATION .....	4
1.3 FEATURES .....	4
<b>2. GENERAL SPECIFICATIONS.....</b>	<b>5</b>
<b>3. BLOCK DIAGRAM.....</b>	<b>6</b>
<b>4. DETAILED SPECIFICATIONS.....</b>	<b>8</b>
4.1 MECHANICAL SPECIFICATIONS .....	8
4.2 ABSOLUTE MAXIMUM RATINGS.....	8
4.3 ELECTRICAL CHARACTERISTICS.....	9
4.3.1 LCD panel signal processing board .....	9
4.3.2 Backlight.....	10
4.3.3 Power supply voltage ripple.....	10
4.3.4 Fuse.....	10
4.4 POWER SUPPLY VOLTAGE SEQUENCE.....	11
4.4.1 LCD panel signal processing board .....	11
4.4.2 Backlight lighting circuit .....	11
4.5 CONNECTIONS AND FUNCTIONS FOR INTERFACE PINS .....	12
4.5.1 LCD panel signal processing board .....	12
4.5.2 Backlight.....	13
4.5.3 Positions of plug and socket .....	13
4.6 DISPLAY COLORS AND INPUT DATA SIGNALS.....	14
4.7 DISPLAY POSITIONS AND SCANNING DIRECTIONS .....	15
4.7.1 Setting the LCD module in the landscape position (horizontal) .....	15
4.7.2 Setting the LCD module in the portrait position (vertical) .....	16
4.8 INPUT SIGNAL TIMINGS .....	17
4.8.1 Outline of input signal timings .....	17
4.8.2 Timing characteristics.....	18
4.8.3 Input signal timing chart.....	20
4.9 OPTICS.....	23
4.9.1 Optical characteristics.....	23
4.9.2 Definition of contrast ratio.....	24
4.9.3 Definition of luminance uniformity .....	24
4.9.4 Definition of response times .....	24
4.9.5 Definition of viewing angles.....	24
<b>5. ESTIMATED LUMINANCE LIFETIME.....</b>	<b>25</b>
<b>6. RELIABILITY TESTS .....</b>	<b>26</b>
<b>7. PRECAUTIONS .....</b>	<b>27</b>
7.1 MEANING OF CAUTION SIGNS .....	27
7.2 CAUTIONS .....	27
7.3 ATTENTIONS.....	27
7.3.1 Handling of the product .....	27
7.3.2 Environment.....	28
7.3.3 Characteristics.....	28
7.3.4 Other .....	28
<b>8. OUTLINE DRAWINGS.....</b>	<b>29</b>
<b>REVISION HISTORY .....</b>	<b>30</b>

## 1. OUTLINE

### 1.1 STRUCTURE AND PRINCIPLE

Color LCD module NL6448BC18-03F is composed of the amorphous silicon thin film transistor liquid crystal display (a-Si TFT LCD) panel structure with driver LSIs for driving the TFT (Thin Film Transistor) array and a backlight.

The a-Si TFT LCD panel structure is injected liquid crystal material into a narrow gap between the TFT array glass substrate and a color-filter glass substrate.

Color (Red, Green, Blue) data signals from a host system (e.g. signal generator, etc.) are modulated into best form for active matrix system by a signal processing circuit, and sent to the driver LSIs which drive the individual TFT arrays.

The TFT array as an electro-optical switch regulates the amount of transmitted light from the backlight assembly, when it is controlled by data signals. Color images are created by regulating the amount of transmitted light through the TFT array of red, green and blue dots.

### 1.2 APPLICATION

- For industrial use

### 1.3 FEATURES

- High luminance
- High contrast
- Wide viewing angle
- Wide temperature range
- 6-bit digital RGB signals
- Reversible-scan direction
- LED backlight type
- Replaceable LED holder for backlight
- Suitable for setting in the portrait position (See "**4.7.2 Setting the LCD module in the portrait position (vertical)**").

Comparison table of NL6448BC18-03F and NL6448BC18-01F

Item	NL6448BC18-03F	NL6448BC18-01F
Designed viewing direction	At DPSH = low or open, At DPSV = high or open : Normal scan • Viewing direction without image reversal : up side (3 o'clock) • Viewing direction with contrast peak : down side (9 o'clock) • Viewing angle with optimum grayscale ( $\gamma \approx 2.2$ ) : normal axis(perpendicular)	At DPSH= low or open, At DPSV = high or open : Normal scan • Viewing direction without image reversal : up side (12 o'clock) • Viewing direction with contrast peak : down side (6 o'clock) • Viewing angle with optimum grayscale ( $\gamma \approx 2.2$ ) : normal axis(perpendicular)

## 2. GENERAL SPECIFICATIONS

<b>Display area</b>	116.16 (H) × 87.12 (V) mm
<b>Diagonal size of display</b>	15cm (5.7inches)
<b>Drive system</b>	a-Si TFT active matrix
<b>Display color</b>	262,144 colors
<b>Pixel</b>	640 (H) × 480 (V) pixels
<b>Pixel arrangement</b>	RGB (Red dot, Green dot, Blue dot) vertical stripe
<b>Dot pitch</b>	0.0605 (H) × 0.1815 (V) mm
<b>Pixel pitch</b>	0.1815 (H) × 0.1815(V) mm
<b>Module size</b>	135 (W) × 104.6 (H) × 10.5 (D) mm (typ.)
<b>Weight</b>	TBD g (typ.)
<b>Contrast ratio</b>	1,000:1 (typ.)
<b>Viewing angle</b>	At the contrast ratio $\geq 10:1$ <ul style="list-style-type: none"> <li>• Horizontal: Right side 80° (typ.), Left side 80° (typ.)</li> <li>• Vertical: Up side 80° (typ.), Down side 80° (typ.)</li> </ul>
<b>Designed viewing direction</b>	At <i>DPSH</i> = Low or open, At <i>DPSV</i> = High or open: Normal scan <ul style="list-style-type: none"> <li>• Viewing direction without image reversal: up side (3 o'clock)</li> <li>• Viewing direction with contrast peak: down side (9 o'clock)</li> <li>• Viewing angle with optimum grayscale (<math>\gamma \approx 2.2</math>): normal axis (perpendicular)</li> </ul>
<b>Polarizer surface</b>	Clear
<b>Polarizer pencil-hardness</b>	3H (min.) [by JIS K5400]
<b>Color gamut</b>	At LCD panel center 60% (typ.) [against NTSC color space]
<b>Response time</b>	<i>Ton</i> + <i>Toff</i> (10% $\leftrightarrow$ 90%) 18 ms (typ.)
<b>Luminance</b>	At <i>IL</i> = 25 mA 800 cd/m <sup>2</sup> (typ.)
<b>Signal system</b>	6-bit digital signals for data of RGB colors, Dot clock (CLK), Data enable (DE), Horizontal synchronous signal (Hsync), Vertical synchronous signal (Vsync)
<b>Power supply voltage</b>	LCD panel signal processing board: 3.3V
<b>Backlight</b>	LED backlight type:  <div style="border-left: 1px solid black; border-right: 1px solid black; padding: 0 10px; display: inline-block;">                 Replaceable part  <ul style="list-style-type: none"> <li>• Lamp holder set: Type No. TBD</li> </ul> </div>
<b>Power consumption</b>	At <i>IL</i> = 25 mA, Checkered flag pattern TBD W (typ.)

### 3. BLOCK DIAGRAM

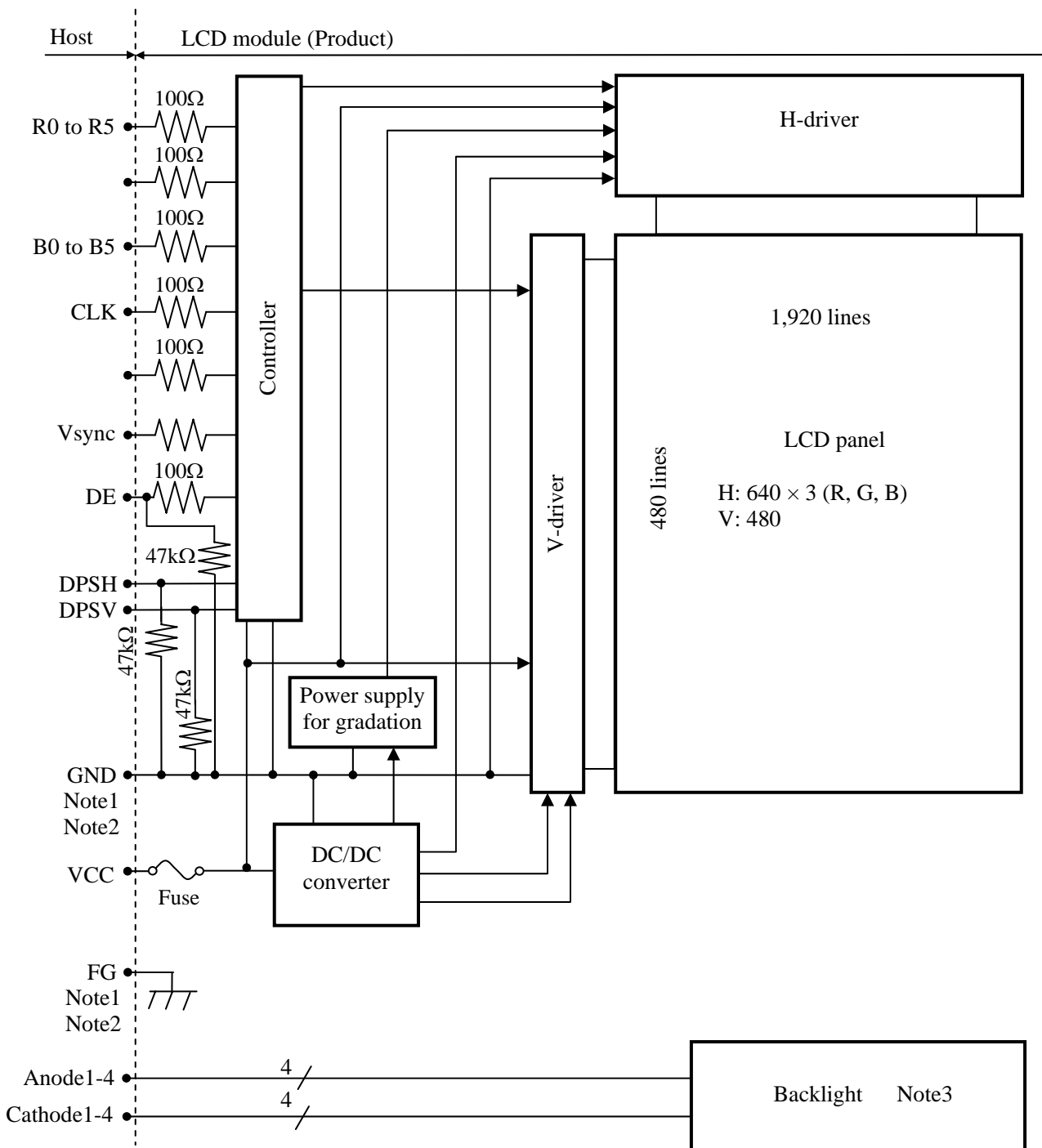

Note1: Relations between GND (Signal ground) and FG (Frame ground) in the LCD module are as follows.

GND - FG	Not Connected
----------	---------------

Note2: GND and FG must be connected to customer equipment's ground, and it is recommended that these grounds are connected together in customer equipment.

# PRELIMINARY

Note3: Backlight in detail

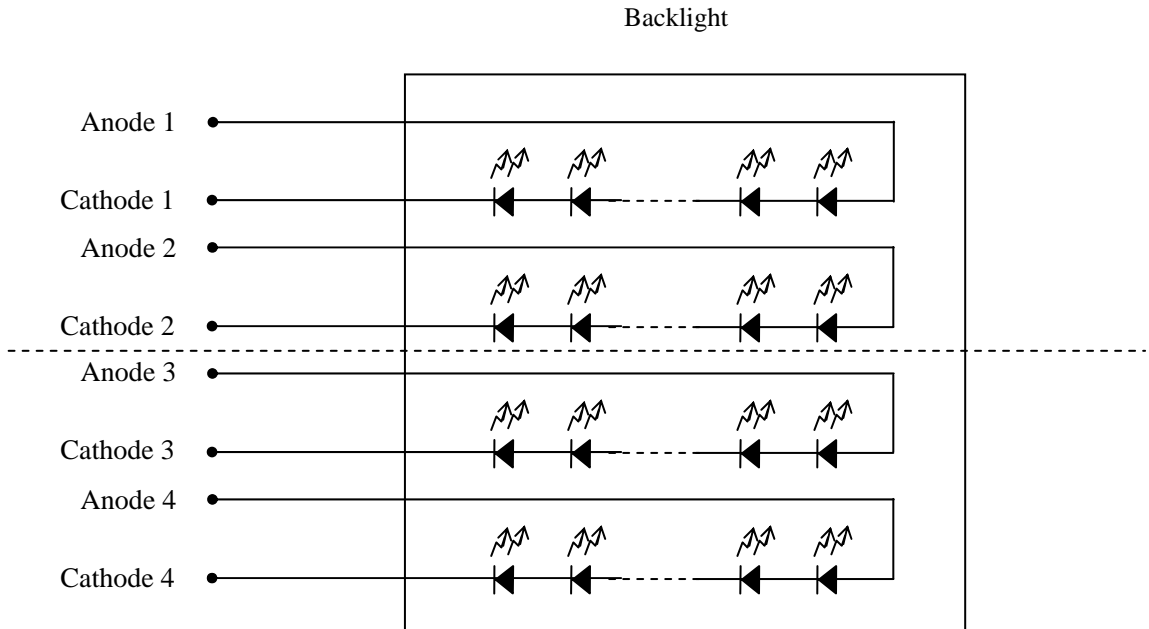

# PRELIMINARY

## 4. DETAILED SPECIFICATIONS

### 4.1 MECHANICAL SPECIFICATIONS

Parameter	Specification	Unit
Module size	135 ± 0.5 (W) × 104.6 ± 0.5 (H) × 10.5 ± 0.5 (D) Note1	mm
Display area	116.16 (H) × 87.12 (V) Note1	mm
Weight	TBD (typ.), TBD (max.)	g

Note1: See "7. OUTLINE DRAWINGS".

### 4.2 ABSOLUTE MAXIMUM RATINGS

Parameter		Symbol	Rating	Unit	Remarks
Power supply voltage	LCD panel signal processing board	VCC	-0.3 to +6.5	V	-
Input voltage for signals	Display signals Note1	VD	-0.3 to VCC+0.3	V	-
	Function signal Note2	VF			
Backlight	Power dissipation	PD	1.1	W	per one circuit
	Forward current	IL	Note3	mA	per one circuit
Storage temperature		Tst	-30 to +80	°C	-
Operating temperature	Front surface	TopF	-20 to +70	°C	Note4
	Rear surface	TopR	-20 to +70	°C	Note5
Relative humidity Note6		RH	≤ 95	%	Ta ≤ 40°C
			≤ 85	%	40 < Ta ≤ 50°C
			≤ 55	%	50°C < Ta ≤ 60°C
			≤ 36	%	60°C < Ta ≤ 70°C
			≤ 24	%	70°C < Ta ≤ 80°C
Absolute humidity Note6		AH	≤ 70 Note7	g/m <sup>3</sup>	Ta = 80°C

Note1: CLK, Hsync, Vsync, DE, DATA (R0 to R5, G0 to G5, B0 to B5)

Note2: DPSH, DPSV



# PRELIMINARY

Note3: Forward current

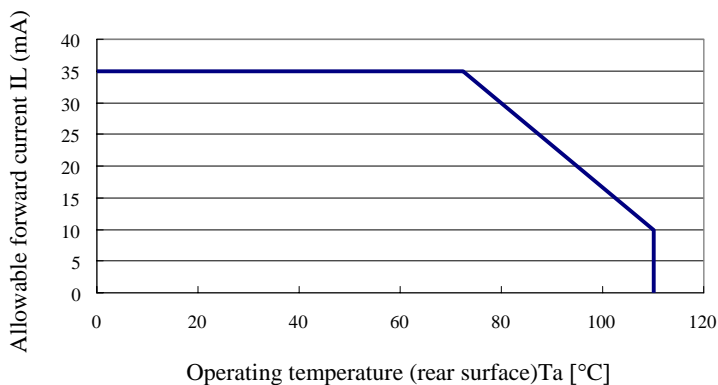

Note4: Measured at center of LCD panel surface (including self-heat)

Note5: Measured at center of LCD module's rear shield surface (including self-heat)

Note6: No condensation

Note7: Water amount at Ta= 70°C and RH= 36%

## 4.3 ELECTRICAL CHARACTERISTICS

### 4.3.1 LCD panel signal processing board

(Ta= 25°C)

Parameter	Symbol	min.	typ.	max.	Unit	Remarks
Power supply voltage	VCC	3.0	3.3	3.6	V	at VCC= 3.3V
Power supply current	ICC	-	TBD Note1	TBD Note2	mA	at VCC= 3.3V
Logic input voltage for display signals	High	VDH	0.7VCC	-	VCC	CMOS level
	Low	VDL	0	-	0.3VCC	
Input voltage for DPSH and DPSV signal	High	VFH	0.7VCC	-	VCC	
	Low	VFL	0	-	0.3VCC	

Note1: Checkered flag pattern [by EIAJ ED-2522]

Note2: Pattern for maximum current

### 4.3.2 Backlight

(Ta=25°C, Note1, Note2)

Parameter	Symbol	min.	typ.	max.	Unit	Remarks
Forward current	IL	-	25	27.5	mA	Note3
Forward Voltage	VL	-	29.7	34.2	V	at IL= 25 mA

Note1: Please drive with constant current.

Note2: The Luminance uniformity may be changed depending on the current variation between 4 circuits.

It is recommended that the current value difference between each circuit is less than 5%.

Note3: See "**4.2 ABSOLUTE MAXIMUM RATINGS Note3**".

### 4.3.3 Power supply voltage ripple

This product works, even if the ripple voltage levels are beyond the permissible values as following the table, but there might be noise on the display image.

Power supply voltage	Ripple voltage (Measure at input terminal of power supply)	Note1	Unit
VCC	3.3V	≤ 100	mVp-p

Note1: The permissible ripple voltage includes spike noise.

### 4.3.4 Fuse

Parameter	Fuse		Rating	Fusing current	Remarks
	Type	Supplier			
VCC	TBD	TBD	TBD	TBD	Note1
			TBD		

Note1: The power supply capacity should be more than the fusing current. If it is less than the fusing current, the fuse may not blow in a short time, and then nasty smell, smoke and so on may occur.

## 4.4 POWER SUPPLY VOLTAGE SEQUENCE

### 4.4.1 LCD panel signal processing board

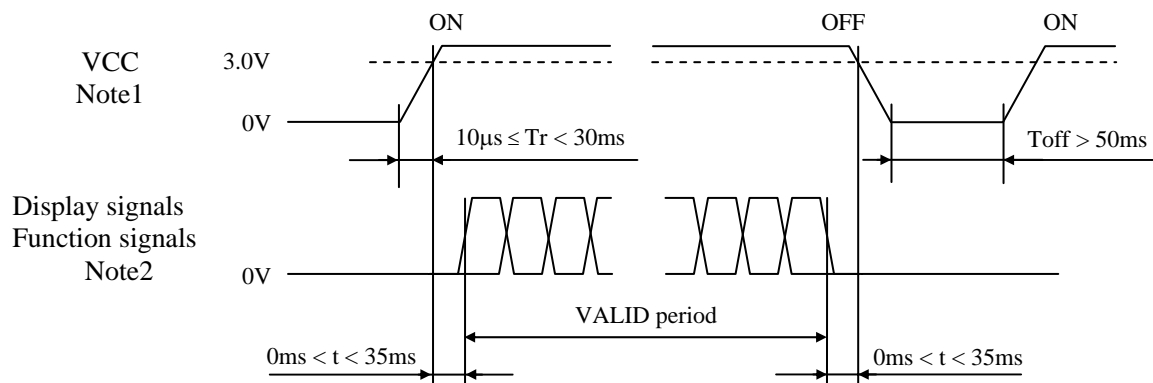

Note1: In terms of voltage variation (voltage drop) while VCC rising edge is below 3.0V, a protection circuit may work, and then this product may not work.

Note2: Display signals (CLK, Hsync, Vsync, DE, DATA (R0 to R5, G0 to G5, B0 to B5)) and function signals (DPSH, DPSV) must be Low or High-impedance, exclude the VALID period (See above sequence diagram), in order to avoid that internal circuits is damaged.

If some of display and function signals of this product are cut while this product is working, even if the signal input to it once again, it might not work normally. VCC should be cut when the display and function signals are stopped.

### 4.4.2 Backlight lighting circuit

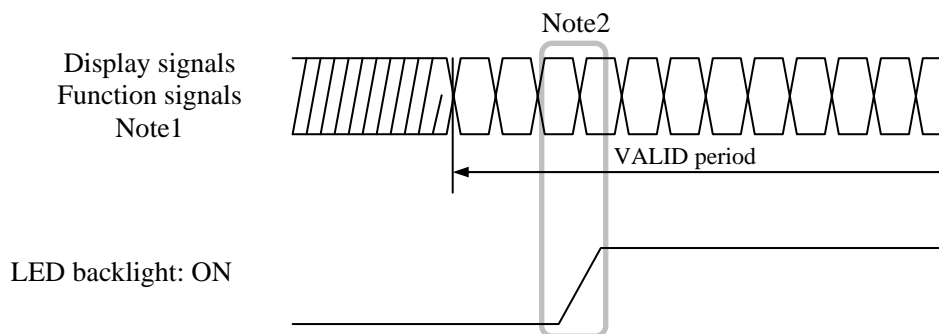

Note1: These are the display and function signals for LCD panel signal processing board.

Note2: The backlight should be turned on within the valid period of display and function signals, in order to avoid unstable data display.

# PRELIMINARY

## 4.5 CONNECTIONS AND FUNCTIONS FOR INTERFACE PINS

### 4.5.1 LCD panel signal processing board

CN1 socket (LCD module side): 08 6260 033 340 829+ (Kyocera Elco Corp.)

Adaptable plug: [0.5mm pitch, Bottom Contact Type]

Pin No.	Symbol	Signal	Remarks
1	GND	Ground	Note1
2	CLK	Dot clock	-
3	Hsync	Horizontal synchronous signal	
4	Vsync	Vertical synchronous signal	
5	GND	Ground	Note1
6	R0	Red data (LSB)	Least significant bit
7	R1	Red data	-
8	R2	Red data	
9	R3	Red data	
10	R4	Red data	
11	R5	Red data (MSB)	Most significant bit
12	GND	Ground	Note1
13	G0	Green data (LSB)	Least significant bit
14	G1	Green data	-
15	G2	Green data	
16	G3	Green data	
17	G4	Green data	
18	G5	Green data (MSB)	Most significant bit
19	GND	Ground	Note1
20	B0	Blue data (LSB)	Least significant bit
21	B1	Blue data	-
22	B2	Blue data	
23	B3	Blue data	
24	B4	Blue data	
25	B5	Blue data (MSB)	Most significant bit
26	GND	Ground	Note1
27	DE	Selection of DE / Fixed mode	Low or Open: Fixed mode Data enable signal: DE mode
28	VCC	Power supply	Note1
29	VCC	Power supply	
30	DPSH	Selection of Horizontal scan direction	High: Reverse scan Low or Open: Normal scan Note2
31	DPSV	Selection of Vertical scan direction	High or Open: Normal scan Low-: Reverse scan Note2
32	N.C.	-	Keep this pin Open.
33	GND	Ground	Note1

Note1: All GND and VCC terminals should be used without any non-connected lines.

Note2: See "4.7 DISPLAY POSITIONS AND SCANNING DIRECTIONS".

# PRELIMINARY

## 4.5.2 Backlight

CN2 plug (LCD module side): SM08B-SRSS-TB (J.S.T. Mfg. Co., Ltd.)

Adaptable socket: SHR-08V-S (J.S.T. Mfg. Co., Ltd.)

Pin No.	Symbol	Signal	Remarks
1	A1	Anode1	-
2	K1	Cathode1	-
3	A2	Anode2	-
4	K2	Cathode2	-
5	N.C.	Keep this pin Open.	-
6	N.C.	Keep this pin Open.	-
7	N.C.	Keep this pin Open.	-
8	N.C.	Keep this pin Open.	-

CN3 plug (LCD module side): SM08B-SRSS-TB (J.S.T. Mfg. Co., Ltd.)

Adaptable socket: SHR-08V-S (J.S.T. Mfg. Co., Ltd.)

Pin No.	Symbol	Signal	Remarks
1	A1	Anode1	-
2	K1	Cathode1	-
3	A2	Anode2	-
4	K2	Cathode2	-
5	N.C.	Keep this pin Open.	-
6	N.C.	Keep this pin Open.	-
7	N.C.	Keep this pin Open.	-
8	N.C.	Keep this pin Open.	-

## 4.5.3 Positions of plug and socket

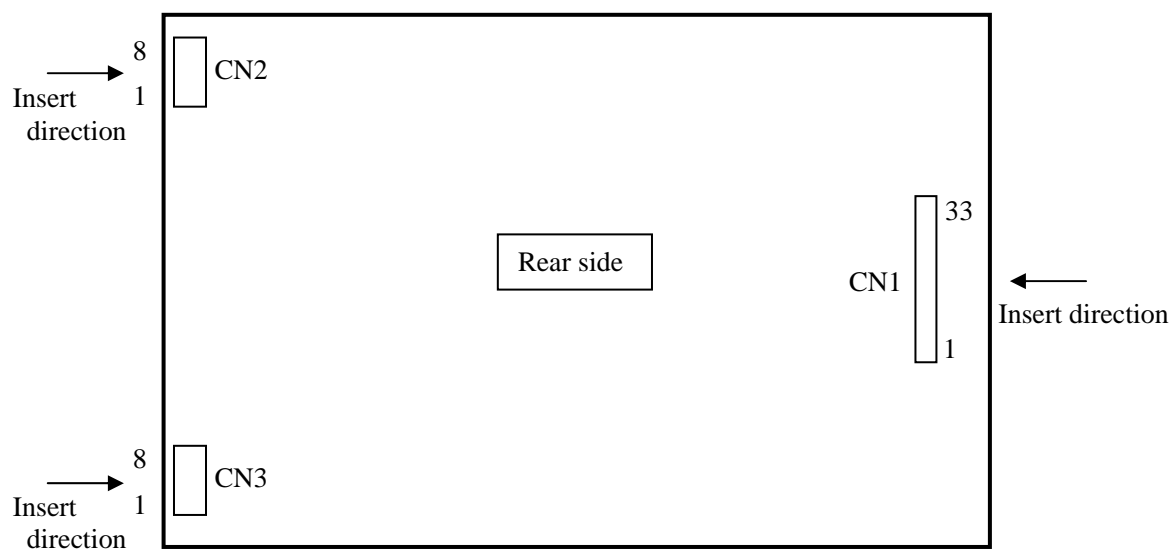

# PRELIMINARY

## 4.6 DISPLAY COLORS AND INPUT DATA SIGNALS

This product can display in equivalent to 262,144 colors in 64 gray scales. Also the relation between display colors and input data signals is as the following table.

Display colors		Data signal (0: Low level, 1: High level)																	
		R5	R4	R3	R2	R1	R0	G5	G4	G3	G2	G1	G0	B5	B4	B3	B2	B1	B0
Basic colors	Black	0	0	0	0	0	0	0	0	0	0	0	0	0	0	0	0	0	0
	Blue	0	0	0	0	0	0	0	0	0	0	0	0	1	1	1	1	1	1
	Red	1	1	1	1	1	1	0	0	0	0	0	0	0	0	0	0	0	0
	Magenta	1	1	1	1	1	1	0	0	0	0	0	0	1	1	1	1	1	1
	Green	0	0	0	0	0	0	1	1	1	1	1	1	0	0	0	0	0	0
	Cyan	0	0	0	0	0	0	1	1	1	1	1	1	1	1	1	1	1	1
	Yellow	1	1	1	1	1	1	1	1	1	1	1	1	0	0	0	0	0	0
	White	1	1	1	1	1	1	1	1	1	1	1	1	1	1	1	1	1	1
Red gray scale	Black	0	0	0	0	0	0	0	0	0	0	0	0	0	0	0	0	0	0
		0	0	0	0	0	1	0	0	0	0	0	0	0	0	0	0	0	0
	dark	0	0	0	0	1	0	0	0	0	0	0	0	0	0	0	0	0	0
	↑				:						:					:			
	↓				:						:					:			
	bright	1	1	1	1	0	1	0	0	0	0	0	0	0	0	0	0	0	0
Red	1	1	1	1	1	1	0	0	0	0	0	0	0	0	0	0	0	0	
Green gray scale	Black	0	0	0	0	0	0	0	0	0	0	0	0	0	0	0	0	0	0
		0	0	0	0	0	0	0	0	0	0	0	1	0	0	0	0	0	0
	dark	0	0	0	0	0	0	0	0	0	0	1	0	0	0	0	0	0	0
	↑				:						:					:			
	↓				:						:					:			
	bright	0	0	0	0	0	0	1	1	1	1	0	1	0	0	0	0	0	0
Green	0	0	0	0	0	0	1	1	1	1	1	1	0	0	0	0	0	0	
Blue gray scale	Black	0	0	0	0	0	0	0	0	0	0	0	0	0	0	0	0	0	0
		0	0	0	0	0	0	0	0	0	0	0	0	0	0	0	0	0	1
	dark	0	0	0	0	0	0	0	0	0	0	0	0	0	0	0	0	1	0
	↑				:						:					:			
	↓				:						:					:			
	bright	0	0	0	0	0	0	0	0	0	0	0	0	1	1	1	1	0	1
Blue	0	0	0	0	0	0	0	0	0	0	0	0	1	1	1	1	1	0	

## 4.7 DISPLAY POSITIONS AND SCANNING DIRECTIONS

### 4.7.1 Setting the LCD module in the landscape position (horizontal)

#### (1) Display positions

The following table is the coordinates per pixel (See figure of "4.7.1 (2) Scanning directions").

C( 0, 0)	C( 1, 0)	...	C( X, 0)	...	C(638, 0)	C(639, 0)
C( 0, 1)	C( 1, 1)	...	C( X, 1)	...	C(638, 1)	C(639, 1)
⋮	⋮	⋮	⋮	⋮	⋮	⋮
C( 0, Y)	C( 1, Y)	...	C( X, Y)	...	C(638, Y)	C(639, Y)
⋮	⋮	⋮	⋮	⋮	⋮	⋮
C( 0, 478)	C( 1,478)	...	C( X,478)	...	C(638,478)	C(639,478)
C( 0,479)	C( 1,479)	...	C( X,479)	...	C(638,479)	C(639,479)

#### (2) Scanning directions

The following figures are seen from a front view. Also the arrow shows the direction of scan.

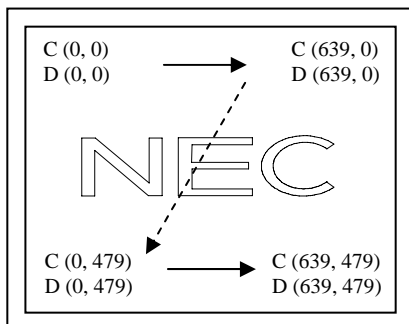

Figure1. DPSH= Low or Open (Normal scan)  
DPSV= High or Open (Normal scan)

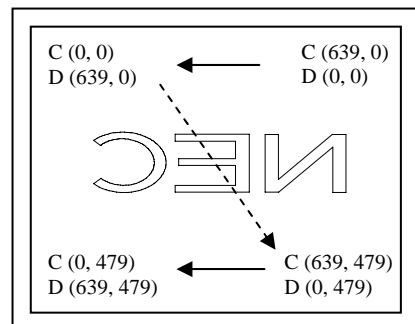

Figure2. DPSH= High (Reverse scan)  
DPSV= High or Open (Normal scan)

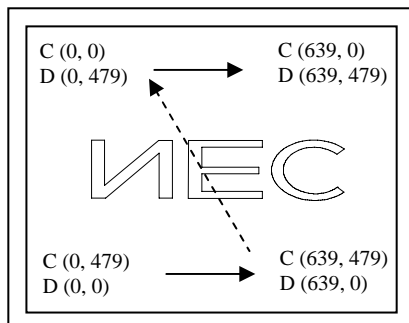

Figure3. DPSH= Low or Open (Normal scan)  
DPSV= Low (Reverse scan)

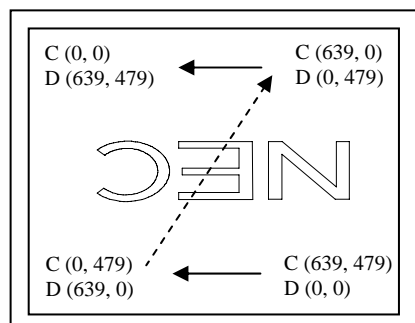

Figure4. DPSH= High (Reverse scan)  
DPSV= Low (Reverse scan)

Note1: Meaning of C (X, Y) and D (X, Y)

C (X, Y): The coordinates of the display position (See "4.7.1 (1) Display positions".)

D (X, Y): The data number of input signal for LCD panel signal processing board

# PRELIMINARY

## 4.7.2 Setting the LCD module in the portrait position (vertical)

### (1) Display positions

The following table is the coordinates per pixel (See figure of "4.7.2 (2) Scanning directions".).

C(639, 0)	C(639, 1)	...	C(639, Y)	...	C(639,478)	C(639,479)
C(638, 0)	C(638, 1)	...	C(638, Y)	...	C(638,478)	C(638,479)
•	•	•	•	•	•	•
•	•	•	•	•	•	•
•	•	•	•	•	•	•
C( X, 0)	C( X, 1)	...	C( X, Y)	...	C( X,478)	C( X,479)
•	•	•	•	•	•	•
•	•	•	•	•	•	•
•	•	•	•	•	•	•
C( 1, 0)	C( 1, 1)	...	C( 1, Y)	...	C( 1,478)	C( 1,479)
C( 0, 0)	C( 0, 1)	...	C( 0, Y)	...	C( 0, 478)	C( 0,479)

### (2) Scanning directions

The following figures are seen from a front view. Also the arrow shows the direction of scan.

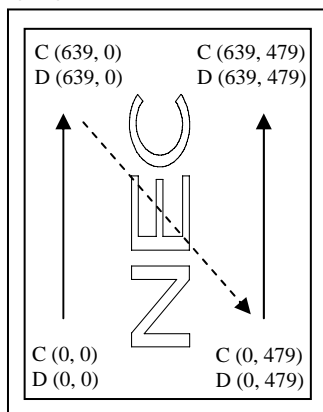

Figure1. DPSH= Low or Open (Normal scan)  
DPSV= High or Open (Normal scan)

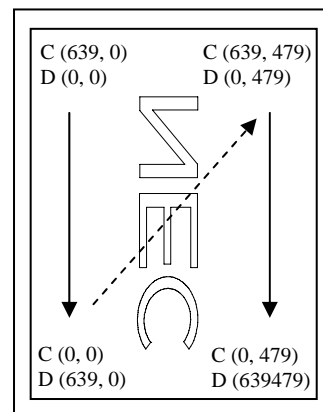

Figure2. DPSH= High (Reverse scan)  
DPSV= High or Open (Normal scan)

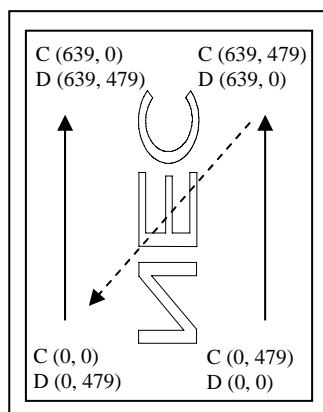

Figure3. DPSH= Low or Open (Normal scan)  
DPSV= Low (Reverse scan)

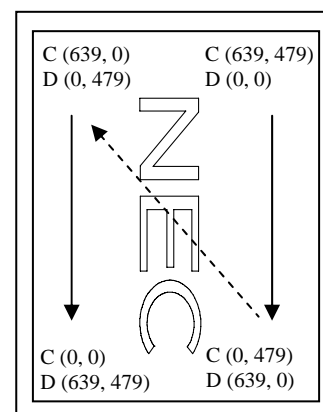

Figure4. DPSH= High (Reverse scan)  
DPSV= Low (Reverse scan)

Note1: Meaning of C (X, Y) and D (X, Y)

C (X, Y): The coordinates of the display position (See "4.7.2 (1) Display positions".)

D (X, Y): The data number of input signal for LCD panel signal processing board



## 4.8 INPUT SIGNAL TIMINGS

### 4.8.1 Outline of input signal timings

- Horizontal signal

Note1

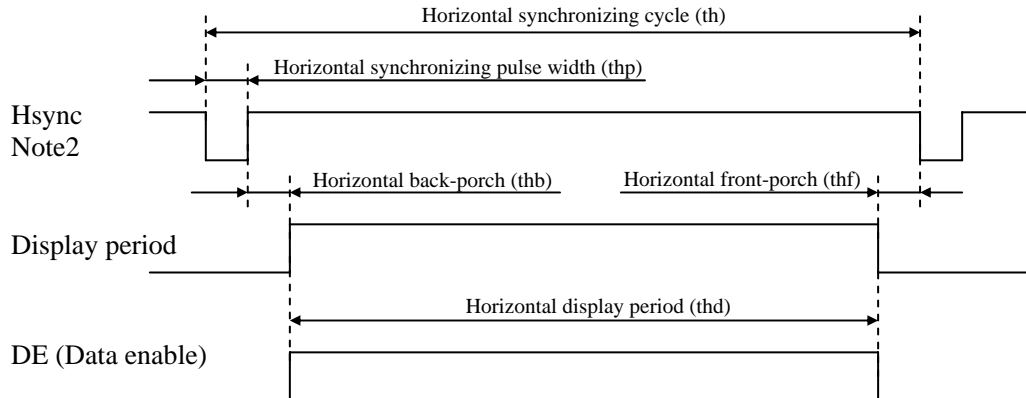

- Vertical signal

Note1

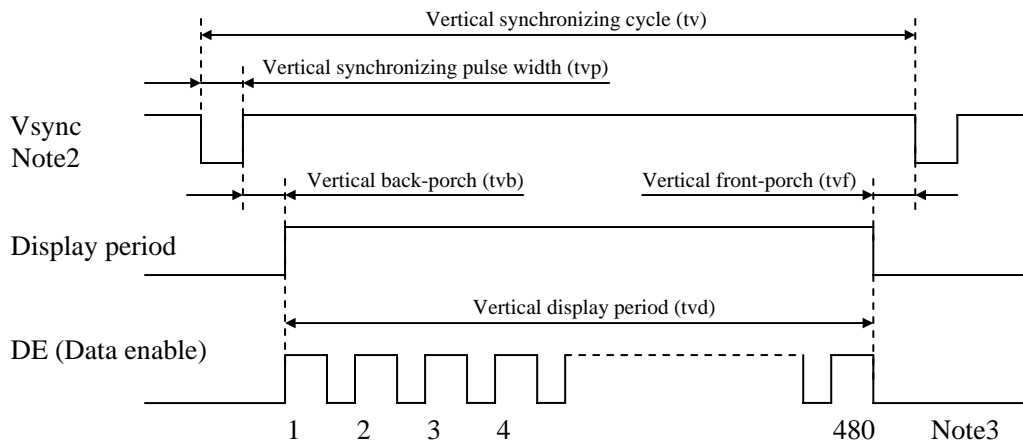

Note1: This diagram indicates virtual signal for set up to timing.

Note2: Fixed mode cannot be used while working of DE mode.

Note3: See "4.8.3 Input signal timing chart" for numeration of pulse.

# PRELIMINARY

## 4.8.2 Timing characteristics

### (a) Fixed mode

(Note1)

Parameter		Symbol	min.	typ.	max.	Unit	Remarks	
CLK	Frequency	1/tc	21.0	25.175	29.0	MHz	39.72ns (typ.)	
	Duty	tcd	0.4	0.5	0.6	-	-	
	Rise time, Fall time	trf	-	-	10	ns	-	
DATA (R0-R5) (G0-G5) (B0-B5)	CLK-DATA	Setup time	tds	10	-	-	ns	-
		Hold time	tdh	10	-	-	ns	
	Rise time, Fall time	tdrf	-	-	10	ns		
Hsync	Cycle	th	30.0	31.778	33.6	μs	31.468kHz (typ.)	
			800			CLK	-	
	Display period	thd	640			CLK		
	Front-porch	thf	16			CLK		
	Pulse width	thp	10	96	-	CLK		
	Back-porch	thb	-	48	134	CLK		
	Total of pulse width and back-porch	thp + thb	144			CLK		Note2
	CLK- Hsync	Setup time	ths	10	-	-		ns
Hold time		thh	10	-	-	ns		
Rise time, Fall time	thrf	-	-	10	ns			
Vsync	Cycle	tv	16.1	16.683	17.2	ms	59.94Hz (typ.)	
			525			H	-	
	Display period	tvd	480			H		
	Front-porch	tvf	12			H		
	Pulse width	tvp	1	2	-	H		
	Back-porch	tvb	-	31	32	H		
	Total of pulse width and back-porch	tvp + tvb	33			H		Note2
	Hsync-Vsync	Setup time	tvhs	10	-	-		ns
Hold time		tvhh	10	-	-	ns		
Rise time, Fall time	tvrf	-	-	10	ns			

Note1: Definition of parameters is as follows.

$$tc = 1CLK, tcd = tch/tc, th = 1H$$

Note2: Keep tvp + tvb and thp + thb within the table. If it is out of specification, display position will be shifted to right/left side or up/down.

# PRELIMINARY

(b) DE mode

(Note1, Note2, Note3)

Parameter		Symbol	min.	typ.	max.	Unit	Remarks	
CLK	Frequency	1/tc	21.0	25.175	29.0	MHz	39.72ns (typ.)	
	Duty	tcd	0.4	0.5	0.6	-	-	
	Rise time, Fall time	terf	-	-	10	ns	-	
DATA (R0-R5) (G0-G5) (B0-B5)	CLK-DATA	Setup time	tds	10	-	-	ns	-
		Hold time	tdh	10	-	-	ns	
	Rise time, Fall time	tdrf	-	-	10	ns		
DE	Horizontal	Cycle	th	30.0	31.778	33.6	μs	31.468kHz (typ.)
				-	800	-	CLK	-
	Vertical (One frame)	Cycle	tv	16.1	16.683	17.2	ms	59.94Hz (typ.)
				-	525	-	H	-
	CLK-DE	Setup time	tdes	10	-	-	ns	-
		Hold time	tdeh	10	-	-	ns	
	Rise time, Fall time	tderf	-	-	10	ns		

Note1: Definition of parameters is as follows.

tc= 1CLK, tcd= tch/tc, th= 1H

Note2: Hsync signal (CN1-Pin No.3) and Vsync signal (CN1-Pin No.4) are not used inside the product at DE mode, but do not keep these pins open to avoid noise problem.

Note3: Vertical cycle (tv) should be specified in integral multiple of Horizontal cycle (th).

### 4.8.3 Input signal timing chart

(a) Fixed mode

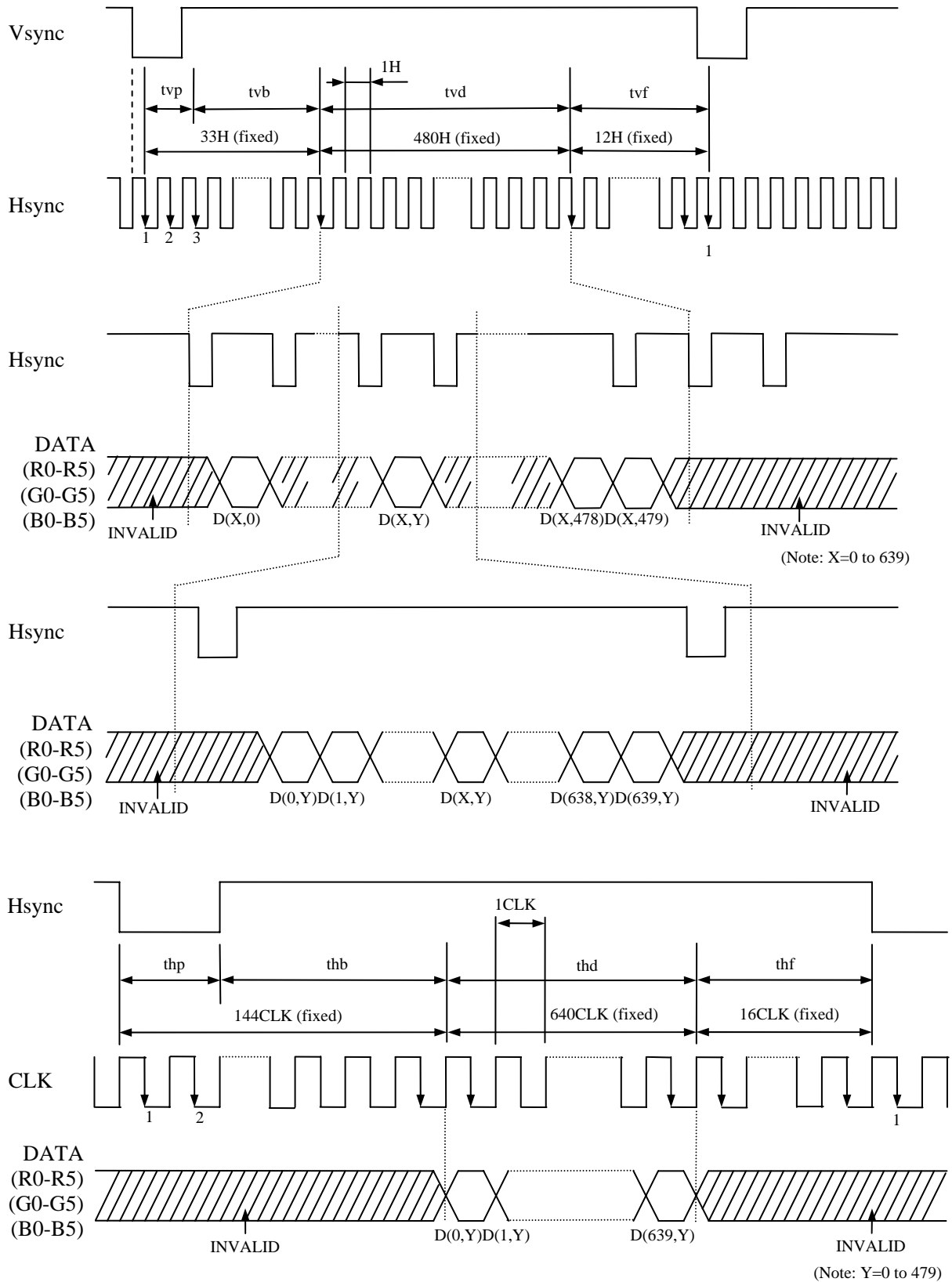

# PRELIMINARY

(b) DE mode

## Horizontal timing

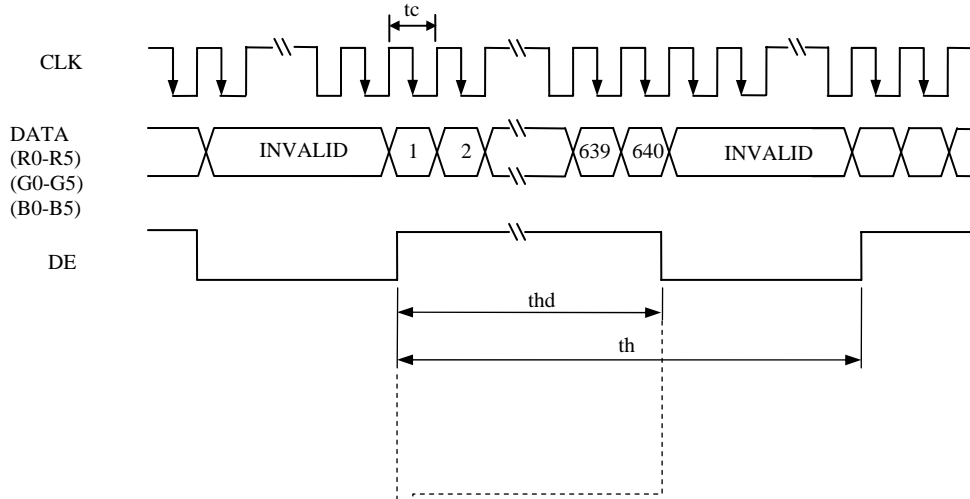

## Vertical timing

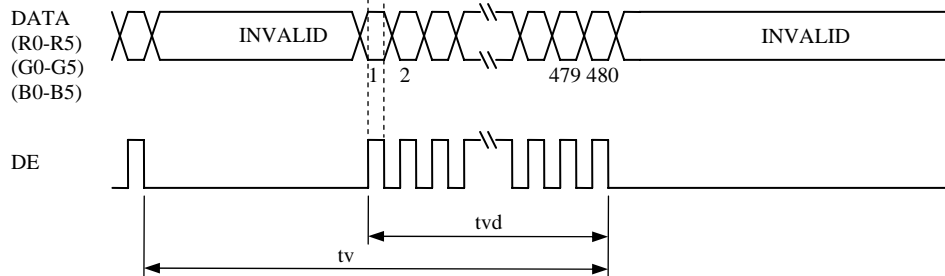

# PRELIMINARY

(c) Common item of Fixed mode and DE mode

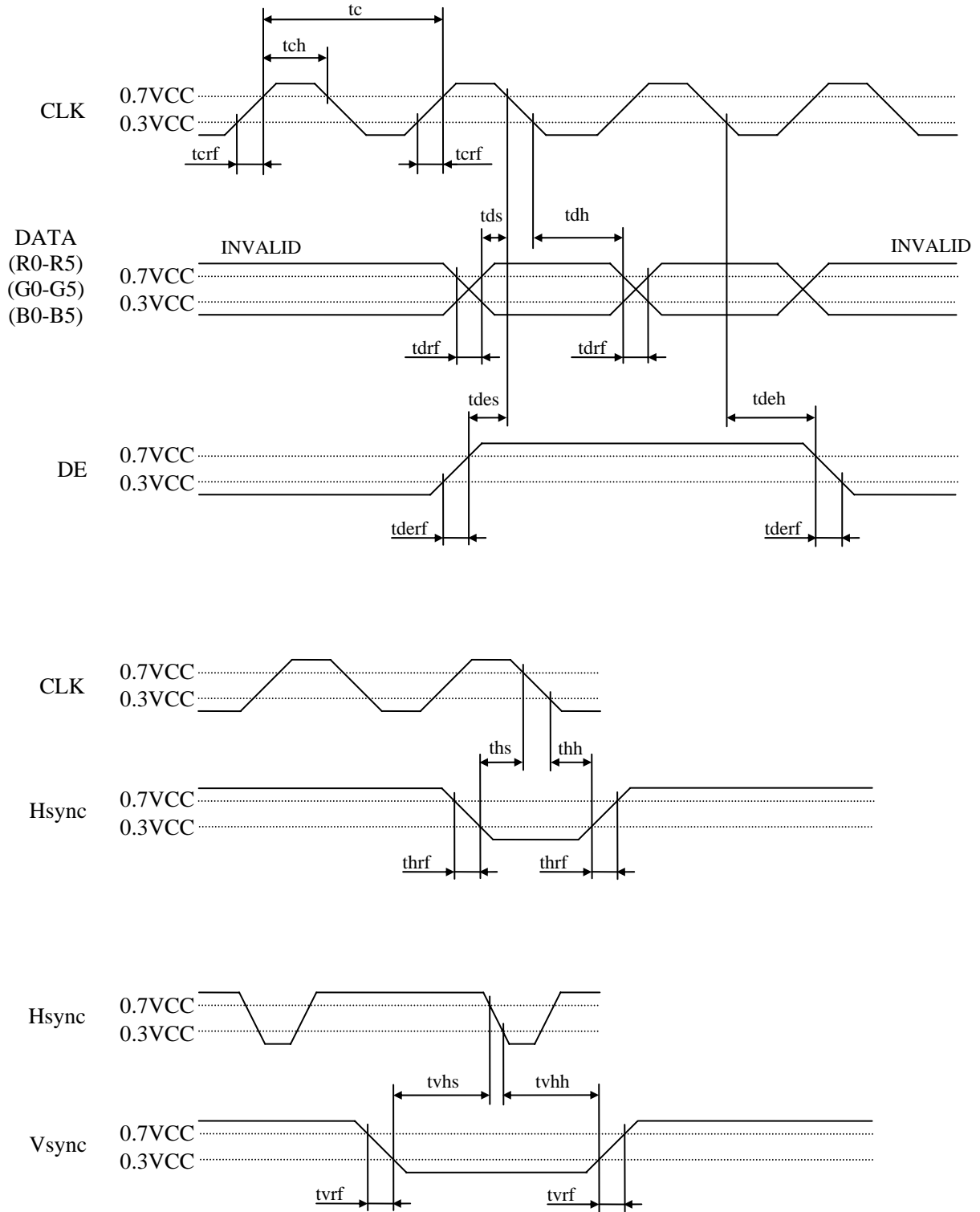

## 4.9 OPTICS

### 4.9.1 Optical characteristics

(Note1, Note2)

Parameter	Condition	Symbol	min.	typ.	max.	Unit	Measuring instrument	Remarks	
Luminance	White at center $\theta R=0^\circ, \theta L=0^\circ, \theta U=0^\circ, \theta D=0^\circ$	L	TBD	800	-	cd/m <sup>2</sup>	BM-5A	-	
Contrast ratio	White/Black at center $\theta R=0^\circ, \theta L=0^\circ, \theta U=0^\circ, \theta D=0^\circ$	CR	TBD	1,000	-	-	BM-5A	Note3	
Luminance uniformity	White $\theta R=0^\circ, \theta L=0^\circ, \theta U=0^\circ, \theta D=0^\circ$	LU	-	1.25	TBD	-	BM-5A	Note4	
Chromaticity	White	x coordinate	Wx	TBD	0.313	TBD	-	SR-3	Note5
		y coordinate	Wy	TBD	0.329	TBD	-		
	Red	x coordinate	Rx	-	TBD	-	-		
		y coordinate	Ry	-	TBD	-	-		
	Green	x coordinate	Gx	-	TBD	-	-		
		y coordinate	Gy	-	TBD	-	-		
Blue	x coordinate	Bx	-	TBD	-	-			
	y coordinate	By	-	TBD	-	-			
Color gamut	$\theta R=0^\circ, \theta L=0^\circ, \theta U=0^\circ, \theta D=0^\circ$ at center, against NTSC color space	C	TBD	60	-	%			
Response time	White to Black	Ton	-	3	TBD	ms	BM-5A	Note6	
	Black to White	Toff	-	15	TBD	ms		Note7	
Viewing angle	Right	$\theta U=0^\circ, \theta D=0^\circ, CR \geq 10$	$\theta R$	TBD	80	-	EZ Contrast	Note8	
	Left	$\theta U=0^\circ, \theta D=0^\circ, CR \geq 10$	$\theta L$	TBD	80	-			
	Up	$\theta R=0^\circ, \theta L=0^\circ, CR \geq 10$	$\theta U$	TBD	80	-			
	Down	$\theta R=0^\circ, \theta L=0^\circ, CR \geq 10$	$\theta D$	TBD	80	-			

Note1: These are initial characteristics.

Note2: Measurement conditions are as follows.

Ta= 25°C, VCC= 3.3V, IL= 25 mA, Display mode: VGA, Horizontal cycle= 1/31.468kHz, Vertical cycle= 1/59.94Hz, DPSH/DPSV= Low or Open/ High or Open: Normal scan

Optical characteristics are measured at luminance saturation after 20minutes from working the product, in the dark room. Also measurement methods are as follows.

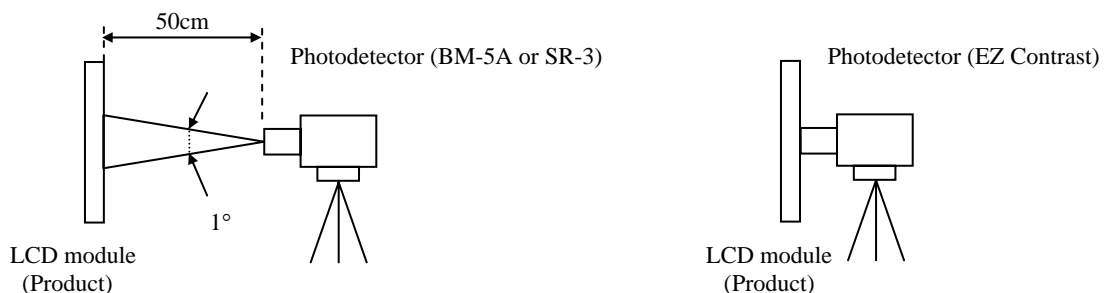

Note3: See "4.9.2 Definition of contrast ratio".

Note4: See "4.9.3 Definition of luminance uniformity".

Note5: These coordinates are found on CIE 1931 chromaticity diagram.

Note6: Product surface temperature: TopF= TBD°C

Note7: See "4.9.4 Definition of response times".

Note8: See "4.9.5 Definition of viewing angles".

# PRELIMINARY

## 4.9.2 Definition of contrast ratio

The contrast ratio is calculated by using the following formula.

$$\text{Contrast ratio (CR)} = \frac{\text{Luminance of white screen}}{\text{Luminance of black screen}}$$

## 4.9.3 Definition of luminance uniformity

The luminance uniformity is calculated by using following formula.

$$\text{Luminance uniformity (LU)} = \frac{\text{Maximum luminance from ① to ⑤}}{\text{Minimum luminance from ① to ⑤}}$$

The luminance is measured at near the 5 points shown below.

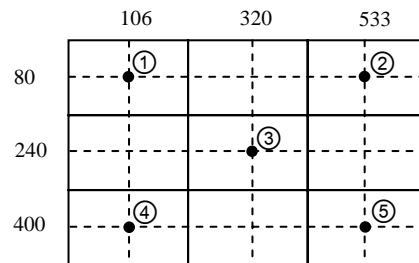

## 4.9.4 Definition of response times

Response time is measured, the luminance changes from "white" to "black", or "black" to "white" on the same screen point, by photo-detector. Ton is the time it takes the luminance change from 90% down to 10%. Also Toff is the time it takes the luminance change from 10% up to 90% (See the following diagram.).

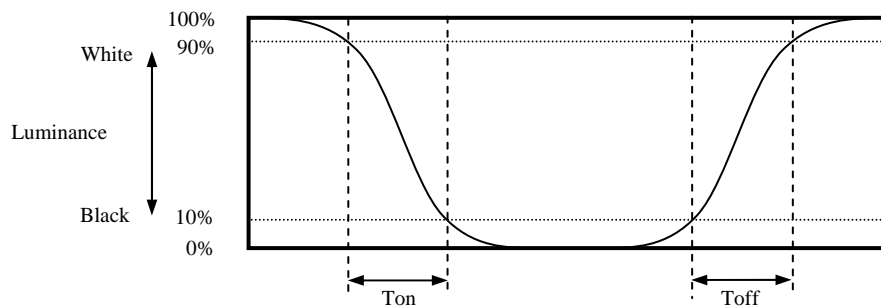

## 4.9.5 Definition of viewing angles

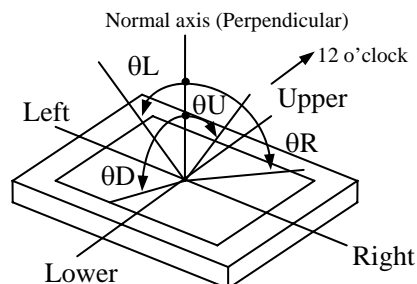



# PRELIMINARY

## 5. ESTIMATED LUMINANCE LIFETIME

The luminance lifetime is the time from initial luminance to half-luminance.

**This lifetime is the estimated value, and is not guarantee value.**

Condition		Estimated luminance lifetime (Life time expectancy) Note1, Note2, Note3	Unit
LED elementary substance	25°C (Ambient temperature of LED) Continuous operation, IL=25mA	50,000	h

Note1: Life time expectancy is mean time to half-luminance.

Note2: Estimated luminance lifetime is not the value for LCD module but the value for LED elementary substance.

Note3: By ambient temperature, the lifetime changes particularly. Especially, in case the product works under high temperature environment, the lifetime becomes short.

**6. RELIABILITY TESTS**

Test item	Condition	Judgment
High temperature and humidity (Operation)	① 60 ± 2°C, RH= 90%, 240hours ② Display data is black.	No display malfunctions Note1
High temperature (Operation)	① 70 ± 3°C, 240hours ② Display data is black.	
Heat cycle (Operation)	① -20 ± 3°C...1hour 70 ± 3°C...1hour ② 50cycles, 4 hours/cycle ③ Display data is black.	
Thermal shock (Non operation)	① -30 ± 3°C...30minutes 80 ± 3°C...30minutes ② 100cycles, 1hour/cycle ③ Temperature transition time is within 5 minutes.	
ESD (Operation)	① 150pF, 150Ω, ±10kV ② 9 places on a panel surface Note2 ③ 10 times each places at 1 sec interval	
Dust (Operation)	① Sample dust: No. 15 (by JIS-Z8901)) ② 15 seconds stir ③ 8 times repeat at 1 hour interval	
Vibration (Non operation)	① 5 to 100Hz, 19.6m/s <sup>2</sup> ② 1 minute/cycle ③ X, Y, Z directions ④ 120 times each directions	No display malfunctions No physical damages Note1
Mechanical shock (Non operation)	① 539m/ s <sup>2</sup> , 11ms ② ±X, ±Y, ±Z directions ③ 5 times each directions	

Note1: Display and appearance are checked under environmental conditions equivalent to the inspection conditions of defect criteria.

Note2: See the following figure for discharge points.

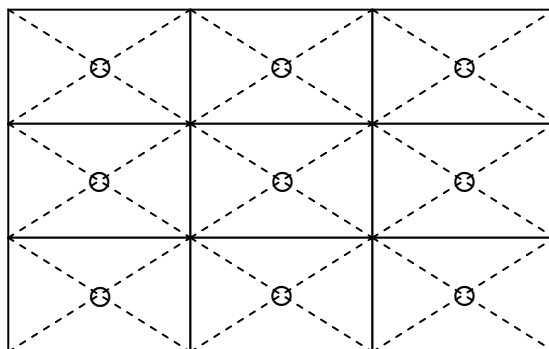

## 7. PRECAUTIONS

### 7.1 MEANING OF CAUTION SIGNS

The following caution signs have very important meaning. **Be sure to read "7.2 CAUTIONS" and "7.3 ATTENTIONS", after understanding these contents!**



This sign has the meaning that customer will be injured by himself or the product will sustain a damage, if customer has wrong operations.



This sign has the meaning that customer will be injured by himself, if customer has wrong operations.

### 7.2 CAUTIONS



- \* Do not touch the working backlight. There is a danger of burn injury.
- \* Do not shock and press the LCD panel and the backlight! There is a danger of breaking, because they are made of glass. (Shock: To be not greater  $539\text{m/s}^2$  and to be not greater 11ms, Pressure: To be not greater 19.6N ( $\phi 16\text{mm}$  jig))

### 7.3 ATTENTIONS



#### 7.3.1 Handling of the product

- ① Take hold of both ends without touching the circuit board when the product (LCD module) is picked up from inner packing box to avoid broken down or misadjustment, because of stress to mounting parts on the circuit board.
- ② Do not hook nor pull cables such as lamp cable, and so on, in order to avoid any damage.
- ③ When the product is put on the table temporarily, display surface must be placed downward.
- ④ When handling the product, take the measures of electrostatic discharge with such as earth band, ionic shower and so on, because the product may be damaged by electrostatic.
- ⑤ The torque for product mounting screws must never exceed 0.147N·m. Higher torque might result in distortion of the bezel.
- ⑥ The product must be installed using mounting holes without undue stress such as bends or twist (See outline drawings). And do not add undue stress to any portion (such as bezel flat area). Bends or twist described above and undue stress to any portion may cause display mura.
- ⑦ Do not press or rub on the sensitive product surface. When cleaning the product surface, use of the cloth with ethanolic liquid such as screen cleaner for LCD is recommended.
- ⑧ Do not push nor pull the interface connectors while the product is working.

- ⑨ When handling the product, use of an original protection sheet on the product surface (polarizer) is recommended for protection of product surface. Adhesive type protection sheet may change color or characteristics of the polarizer.
- ⑩ Usually liquid crystals don't leak through the breakage of glasses because of the surface tension of thin layer and the construction of LCD panel. But, if you contact with liquid crystal for the worst, please wash it out with soap.

### 7.3.2 Environment

- ① Do not operate or store in high temperature, high humidity, dewdrop atmosphere or corrosive gases. Keep the product in packing box with antistatic pouch in room temperature to avoid dusts and sunlight, when storing the product.
- ② In order to prevent dew condensation occurring by temperature difference, the product packing box should be opened after enough time being left under the environment of an unpacking room. Evaluate the leaving time sufficiently because a situation of dew condensation occurring is changed by the environmental temperature and humidity. (Recommended leaving time: 6 hours or more with packing state)
- ③ Do not operate in high magnetic field. Circuit boards may be broken down by it.
- ④ This product is not designed as radiation hardened.

### 7.3.3 Characteristics

**The following items are neither defects nor failures.**

- ① Characteristics of the LCD (such as response time, luminance, color uniformity and so on) may be changed depending on ambient temperature. If the product is stored under condition of low temperature for a long time, it may cause display mura. In this case, the product should be operated after enough time being left under condition of operating temperature.
- ② Display mura, flicker, vertical seam or small spot may be observed depending on display patterns.
- ③ Do not display the fixed pattern for a long time because it may cause image sticking. Use a screen saver, if the fixed pattern is displayed on the screen.
- ④ The display color may be changed depending on viewing angle because of the use of condenser sheet in the backlight.
- ⑤ Optical characteristics may be changed depending on input signal timings.
- ⑥ The interference noise between input signal frequency for this product's signal processing board and luminance control frequency of the backlight driving circuit may appear on a display. Set up luminance control frequency of backlight driving circuit so that the interference noise does not appear.

### 7.3.4 Other

- ① All GND and VCC terminals should be used without any non-connected lines.
- ② Do not disassemble a product or adjust variable resistors.
- ③ See "REPLACEMENT MANUAL FOR LAMP HOLDER SET", when replacing LED backlight.
- ④ Pay attention not to insert foreign materials inside of the product, when using tapping screws.
- ⑤ Pack the product with original shipping package, in order to avoid any damages during transportation, when returning the product to NEC for repair and so on.

8. OUTLINE DRAWINGS

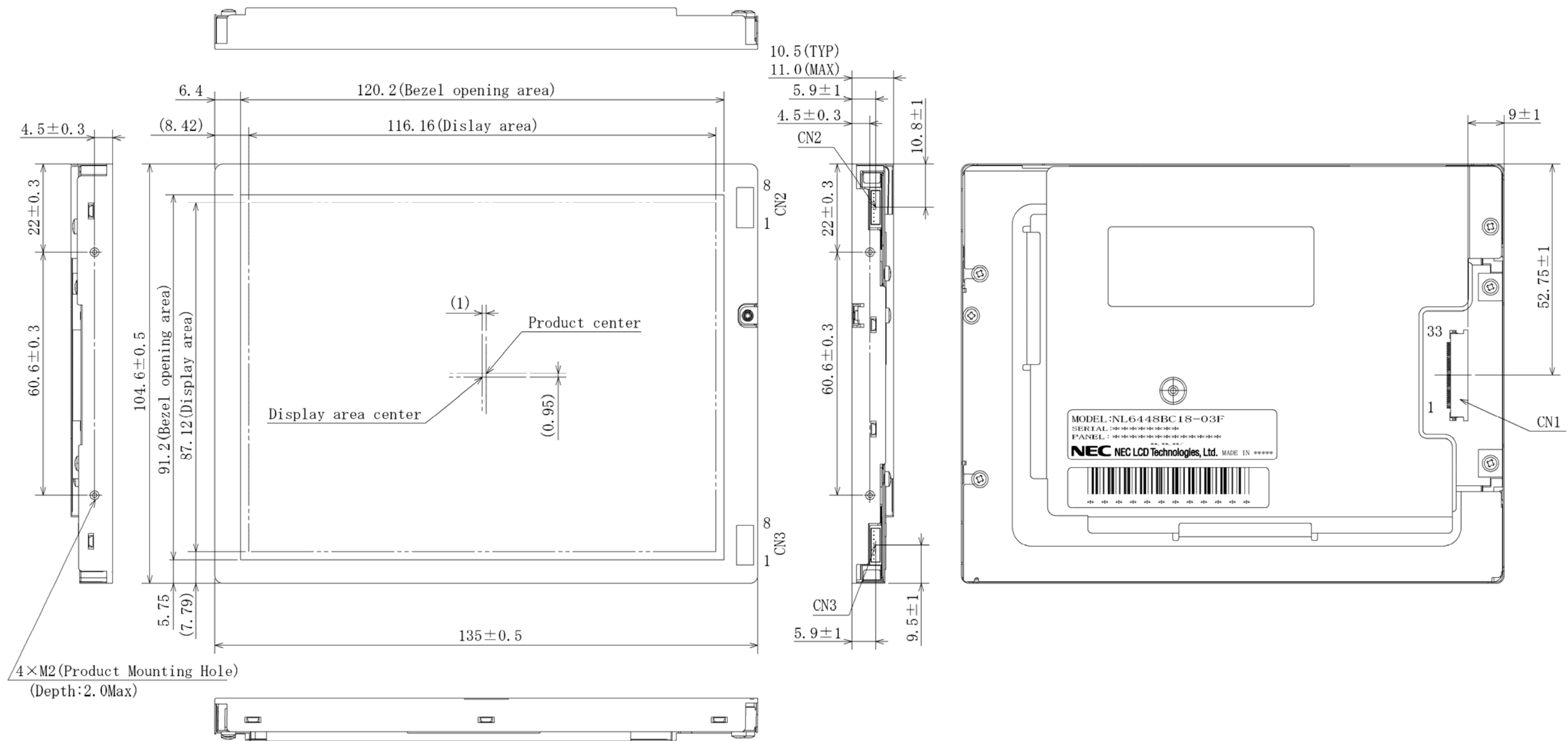

Note1: The values in parentheses are for reference.







Note2: The torque for product mounting screws must never exceed  $0.147N \cdot m$ .

Unit: mm

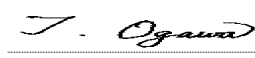
# PRELIMINARY

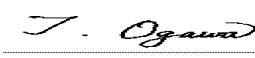
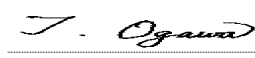
## REVISION HISTORY

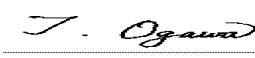
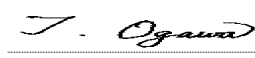
*The inside of latest specifications is revised to the clerical error and the major improvement of previous edition. Only a changed part such as functions, characteristic value and so on that may affect a design of customers, are described especially below.*

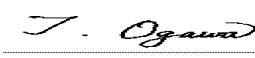
Edition	Document number	Prepared date	Revision contents and signature									
1st edition	DOD-PP-0563	Jun. 24, 2008	<p><b>Revision contents</b></p> <p>New issue</p> <p><b>Signature of writer</b></p> <table style="width: 100%; border: none;"> <tr> <td style="text-align: center; width: 33%;"><i>Approved by</i></td> <td style="text-align: center; width: 33%;"><i>Checked by</i></td> <td style="text-align: center; width: 33%;"><i>Prepared by</i></td> </tr> <tr> <td style="text-align: center;"></td> <td style="text-align: center;"></td> <td style="text-align: center;"></td> </tr> <tr> <td style="text-align: center;">T. OGAWA</td> <td style="text-align: center;">_____</td> <td style="text-align: center;">T. OGAWA</td> </tr> </table>	<i>Approved by</i>	<i>Checked by</i>	<i>Prepared by</i>				T. OGAWA	_____	T. OGAWA
<i>Approved by</i>	<i>Checked by</i>	<i>Prepared by</i>										
												
T. OGAWA	_____	T. OGAWA										