

PREPARED BY : DATE	<h1>SHARP</h1> <p>AVC Liquid Crystal Display Group SHARP CORPORATION</p> <h2>SPECIFICATION</h2>	SPEC No. LD-11Z06D
		FILE No.
APPROVED BY : DATE		ISSUE : Jan. 28 2002
		PAGE : 21 pages
		APPLICABLE GROUP AVC Liquid Crystal Display Group

DEVICE SPECIFICATION FOR

TFT-LCD Module

 MODEL No.

LQ150X1DG51

CUSTOMER'S APPROVAL

DATE _____

BY _____

PRESENTED
 BY *Makoto Takeda*
 M. TAKEDA
 Department General Manager
 Development Engineering Department 2
 AVC Liquid Crystal Display Division
 AVC Liquid Crystal Display Group
 SHARP Corporation

1. Application

This specifications applies to a color TFT-LCD module, LQ150X1DG51.

These specification sheets are the proprietary product of SHARP CORPORATION("SHARP) and include materials protected under copyright of SHARP. Do not reproduce or cause any third party to reproduce them in any form or by any means, electronic or mechanical, for any purpose, in whole or in part, without the express written permission of SHARP .

The device listed in these specification sheets was designed and manufactured for use in OA equipment .

In case of using the device for applications such as control and safety equipment for transportation(aircraft, trains, automobiles, etc.), rescue and security equipment and various safety related equipment which require higher reliability and safety, take into consideration that appropriate measures such as fail-safe functions and redundant system design should be taken .

Do not use the device for equipment that requires an extreme level of reliability, such as aerospace applications, telecommunication equipment(trunk lines), nuclear power control equipment and medical or other equipment for life support .

SHARP assumes no responsibility for any damage resulting from the use of the device which does not comply with the instructions and the precautions specified in these specification sheets .

Contact and consult with a SHARP sales representative for any questions about this device .

2. Overview

This module is a color active matrix LCD module incorporating amorphous silicon TFT (Thin Film Transistor). It is composed of a color TFT-LCD panel, driver ICs, control circuit, power supply circuit and a back light unit. Graphics and texts can be displayed on a 1024 × 3 × 768 dots panel with 262,144 colors by supplying 36 bit data signals(6 bit × 2pixel × RGB), four timing signals, +5V DC supply voltage for TFT-LCD panel driving and supply voltage for back light .

It is a wide viewing-angle-module (Vertical viewing angle:120 ° Horizontal viewing angle:140 ° ,CR 5).

Input signal timing conform with 75Hz mode of VESA standard.

This LCD module with new color filter is suitable for the LCD monitor applications where high vivid color saturation, and high color depth are very important.

3. Mechanical Specifications

Parameter	Specifications	Unit
Display size	38 (Diagonal)	cm
	15.0 (Diagonal)	inch
Active area	304.1 (H) × 228.1 (V)	mm
Pixel format	1024 (H) × 768 (V)	pixel
	(1 pixel = R + G + B dots)	
Pixel pitch	0.297 (H) × 0.297 (V)	mm
Pixel configuration	R,G,B vertical stripe	
Display mode	Normally white	
Unit outline dimensions *1	340.0 (W) × 264.0 (H) × 15.0 (D)	mm
Mass	Max.1350	g
Surface treatment	Anti-glare and hard-coating 2H (Haze value = 28)	

*1.Note: excluding back light cables .

The thickness of module (D) doesn't contain the projection .

*2.Outline dimension is shown in Fig.1

4. Input Terminals

4-1. TFT-LCD panel driving

CN1

The module-side connector : FX8-60S-SV (Hirose Electric Co., Ltd.)

The user-side connector : FX8-60P-SV (Hirose Electric Co., Ltd.)

Pin No.	Symbol	Function	Remark	Pin No.	Symbol	Function	Remark
1	GND	GND		2	RB0	RED even data signal (LSB)	
3	RB1	RED even data signal		4	RB2	RED even data signal	
5	RB3	RED even data signal		6	RB4	RED even data signal	
7	RB5	RED even data signal (MSB)		8	GND	GND	
9	GB0	GREEN even data signal (LSB)		10	GB1	GREEN even data signal	
11	GB2	GREEN even data signal		12	GB3	GREEN even data signal	
13	GB4	GREEN even data signal		14	GB5	GREEN even data signal (MSB)	
15	GND	GND		16	BB0	BLUE even data signal (LSB)	
17	BB1	BLUE even data signal		18	BB2	BLUE even data signal	
19	BB3	BLUE even data signal		20	BB4	BLUE even data signal	
21	BB5	BLUE even data signal (MSB)		22	GND	GND	
23	RA0	RED odd data signal (LSB)		24	RA1	RED odd data signal	
25	RA2	RED odd data signal		26	RA3	RED odd data signal	
27	RA4	RED odd data signal		28	RA5	RED odd data signal (MSB)	
29	GND	GND		30	GA0	GREEN odd data signal (LSB)	
31	GA1	GREEN odd data signal		32	GA2	GREEN odd data signal	
33	GA3	GREEN odd data signal		34	GA4	GREEN odd data signal	
35	GA5	GREEN odd data signal (MSB)		36	GND	GND	
37	BA0	BLUE odd data signal (LSB)		38	BA1	BLUE odd data signal	
39	BA2	BLUE odd data signal		40	BA3	BLUE odd data signal	
41	BA4	BLUE odd data signal		42	BA4	BLUE odd data signal	
43	GND	GND		44	GND	GND	
45	GND	GND		46	Vsync	Vertical synchronous signal	
47	Hsync	Horizontal synchronous signal		48	ENAB	Data enable signal (Signal to settle the display position)	
49	GND	GND (Reserve)		50	GND	GND	
51	CKB	Clock B signal for sampling even data signal		52	CKA	Clock A signal for sampling odd data signal	
53	GND	GND		54	GND	GND (Reserve)	
55	CKPOL	Ck edge select for sampling Data.ENAB.Hsync		56	MODE	Timing signal select	
57	Vcc	+5V power supply		58	Vcc	+5V power supply	
59	Vcc	+5V power supply		60	Vcc	+5V power supply	

The shielding case is connected with GND in the module .

【Note 1】 In case MODE is fixed “Low”, the display start timing is determined by Vsync and ENAB.

The vertical display start position and horizontal display start position are determined as described in 7-1-2, 7-1-3. Do not keep ENAB “high” during operation.

In case MODE is fixed “High” or “Open”, the display start timing is determined by only ENAB.

【Note 2】

Data,ENAB,Hsync

CKA,CKB

In case CKPOL is “Low”

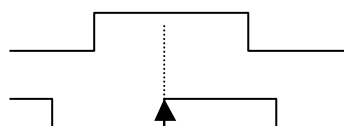

The rising sampling timing

In case CKPOL is “High”

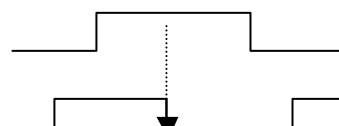

The falling edge

4-2. Back light driving

CN2, CN4 The module-side connector : BHSR-02VS-1(JST)

 The user-side connector : SM02B-BHSS-1-TB(JST)

Pin no.	symbol	function
1	V_{HIGH-1}	Power supply for lamp (High voltage side 1)
2	V_{HIGH-2}	Power supply for lamp (High voltage side 2)

CN3, CN5 The module-side connector : BHR-02VS-1(JST)

 The user-side connector : SM02(4.0)B-BHS-1-TB(JST)

Pin no.	symbol	function
1	V_{LOW-1}	Power supply for lamp (Low voltage side 1)
2	V_{LOW-2}	Power supply for lamp (Low voltage side 2)

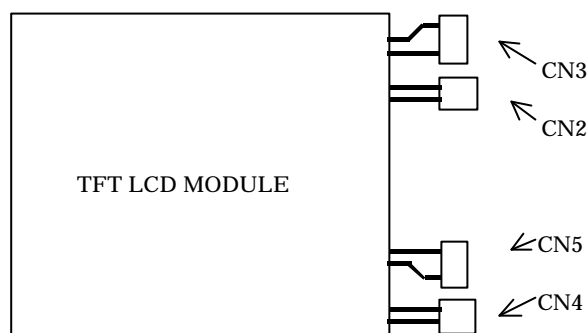

5. Absolute Maximum Ratings

Parameter	Symbol	Condition	Ratings	Unit	Remark
Input voltage	V_I	$T_a=25$	- 0.3 ~ + 5.5	V	【Note1】
+5.0V supply voltage	V_{CC}	$T_a=25$	0 ~ + 6	V	
Storage temperature	T_{stg}	-	- 25 ~ + 60		【Note2】
Operating temperature (Ambient)	T_{opa}	-	0 ~ + 50		

【Note1】 CKA, CKB, RA0 ~ RA5, GA0 ~ GA5, BA0 ~ BA5, RB0 ~ RB5, GB0 ~ GB5, BB0 ~ BB5,
Hsync, Vsync, ENAB, MODE, CKPOL

【Note2】 Humidity : 95%RH Max. (T_a 40)

Maximum wet-bulb temperature at 39 or less ($T_a > 40$)

No condensation.

6. Electrical Characteristics

6-1. TFT-LCD panel driving

Ta = 25

Parameter		Symbol	Min.	Typ.	Max.	Unit	Remark
Vcc	Supply voltage	Vcc	+4.5	+5.0	+5.5	V	【Note1】
	Current dissipation	Icc	-	360	530	mA	【Note2】
Permissive input ripple voltage		V _{RF}	-	-	100	mVp-p	Vcc=+5.0V
Input voltage (Low)		V _{IL}	GND	-	0.6	V	【Note3】
Input voltage (High)		V _{IH}	2.6	-	Vcc	V	【Note3】
Input current (Low)		I _{IL}	-	-	10	μA	V _I =GND 【Note3,5】
			-	-	400	μA	V _I =GND 【Note4】
Input current (High)		I _{IH}	-	-	10	μA	V _I =Vcc 【Note3】
			-	-	600	μA	V _I =Vcc 【Note4】

3,4

3.3(v) logic is recommended as input signals .

【Note1】

On-off conditions for supply voltage

$$0 < t_1 \leq 10\text{ms} \quad 0 < t_2 \leq 10\text{ms}$$

$$0 < t_3 \leq 1\text{s} \quad t_4 \leq 1\text{s}$$

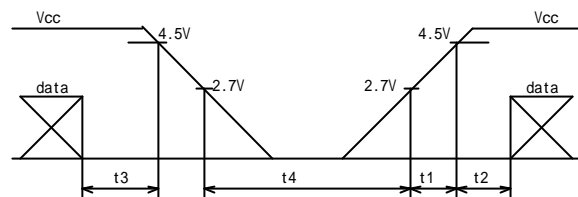

Vcc-dip conditions

- 1) 2.7V Vcc < 4.5V
td 10ms
- 2) Vcc < 2.7V

Vcc-dip conditions should also follow the on-off conditions

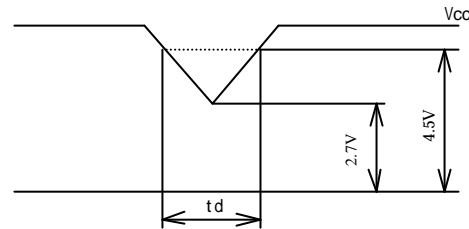

【Note2】 Typical current situation : 16-gray-bar pattern.

Vcc=+5.0V,CK:32.5MHz,TH:20.7 μs

Gray scale : GS(4n)
n=0 ~ 15

The explanation of each gray scale ,GS(4n), is described below section (8).

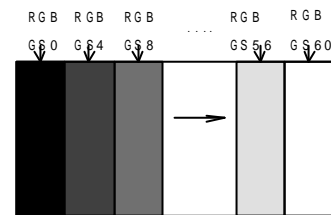

【Note3】 CKA, CKB, RA0 ~ RA5, GA0 ~ GA5, BA0 ~ BA5, RB0 ~ RB5, GB0 ~ GB5, BB0 ~ BB5,

Hsync, Vsync, ENAB

【Note4】 MODE

Input circuit of MODE is shown in right figure.

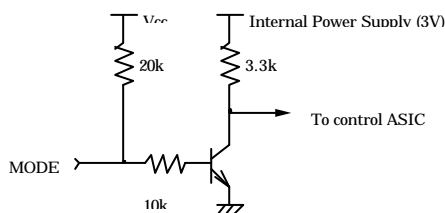

CKPOL

Input circuit of MODE is shown in right figure.

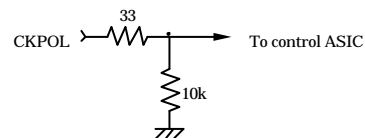

6-2. Back light driving 1 2

The back light system is an edge-lighting type with four CCFTs (Cold Cathode Fluorescent Tube).

The characteristics of the lamp are shown in the following table .

The value mentioned below is at the case of one CCFT .

CCFT Model Name : FL-26314(C9)-LQ150 (TOA ELEVAM Co.,Ltd)

Parameter	Symbol	Min.	Typ.	Max.	Unit	Remark
Lamp current range	I_L	3.5	6.0	6.5	mArms	【Note1】
Lamp voltage	V_L	-	630	-	Vrms	$T_a=25$
Lamp power consumption	P_L	-	3.8	-	W	【Note2】
Lamp frequency	F_L	20	60	70	KHz	【Note3】
Kick-off voltage	V_s	-	-	800	Vrms	$T_a=25$ 【Note4】
		-	-	1420	Vrms	$T_a=0$ 【Note4】
Lamp life time	L_L	50000	-	-	hour	【Note5】

2

【Note1】 A lamp can be light in the range of lamp current shown above .

Maximum rating for current is measured by high frequency current measurement equipment connected to V_{LOW} at circuit showed below .

(Note : To keep enough kick-off voltage and necessary steady voltage for CCFT .)

Lamp frequency : 20 ~ 70kHz

Ambient temperature : 0 ~ 50

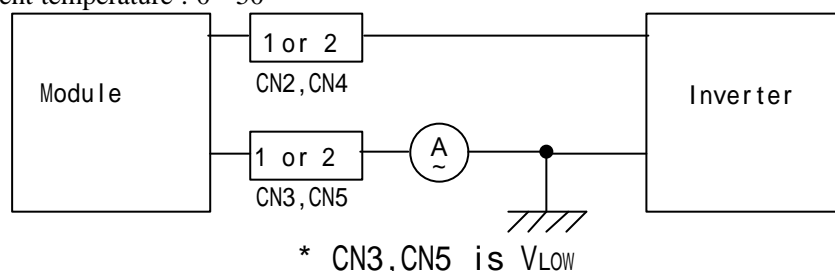

【Note2】 Referential data per one CCFT by calculation ($I_L \times V_L$).

The data doesn't include loss at inverter .

【Note3】 Lamp frequency of inverter may produce interference with horizontal synchronous frequency, and this may cause horizontal beat on the display. Therefore, adjust lamp frequency, and keep inverter as far as from module or use electronic shielding between inverter and module to avoid interference.

【Note4】 Kick-off voltage value is described as the index in the state of lamp only.

The kick-off voltage is estimated to be risen up as approx. +200V in the state of module only, and the further rise up can be seen according to the assembling status of user cabinet. Please set the kick-off voltage of inverter to avoid the lighting failures in the state of operation. Please design the inverter so that its open output voltage can be connected for more than 1 second to startup. Otherwise, the lamp may not be turned on. But, please set as 100ms when the ambient luminance around the lamp is more than 1 lux.

【Note5】 Lamp life time is defined as the time when either or occurs in the continuous operation under the condition of $T_a=25$ and $I_L=6.0 \pm 0.5\text{mArms}$.

Brightness becomes 50% of the original value under standard condition .

Kick-off voltage at $T_a=0$ exceeds maximum value, 1420Vrms .

《Note》 The performance of the back light, for example life time or brightness, is much influenced by the characteristics

of the DC-AC inverter for the lamp .When you design or order the inverter, please make sure that a poor lighting

caused by the mismatch of the back light and the inverter (miss-lighting, flicker, etc.) never occurs . When you confirm it, the module should be operated in the same condition as it is installed in your instrument .

- 1 Use the lamp inverter power source incorporating such safeguard as overvoltage/overcurrent protective circuit or lamp voltage waveform detection circuit, which should have individual control of each lamp.

In case one circuit without such individual control is connected to more than two lamps, excessive current may flow into one lamp when the other one is not in operation.

7. Timing characteristics of input signals

7-1. H-V mode (MODE = “Low”)

Timing diagrams of input signal are shown in Fig.2-1 (CKPOL = “Low”), Fig.2-2 (CKPOL = “High”).

7-1-1. Timing characteristics

Parameter		Symbol	Min.	Typ.	Max.	Unit	Remark
Clock A	Frequency	1/Tc	25	32.5	40	MHz	
Clock B	High time	Tch	9	-	-	ns	
	Low time	Tcl	9	-	-	ns	
	Duty ratio	Tch/Tcl	0.67	1.00	1.50		
	Phase difference	Tcp	-4	0	+4	ns	
Data	Setup time	Tds	5	-	-	ns	
	Hold time	Tdh	5	-	-	ns	
Horizontal sync. signal	Cycle	TH	16.6	20.7	-	μs	
			528	672	860	clock	
	Pulse width	THp	2	68	-	clock	
Horizontal data start		THbp	-	-	-	clock	【Note1】
Hsync-Ck	Setup time	THs	5	-	-	ns	
	Hold time	THh	5	-	-	ns	
Vertical sync. signal	Cycle	TV	-	16.7	-	ms	【Note2】
			773	806	990	line	
	Pulse width	TVp	1	6	-	line	
Vertical data start		TVbp	35	35	35	line	
Hsync-Vsync phase difference		TVh	1	-	TH-THp	clock	

【Note1】 Horizontal data start is determined only by data enable signal.

【Note2】 In case of lower frequency, the deterioration of display quality, flicker etc may be occurred .

7-1-2. Horizontal display position

The horizontal display position is determined by ENAB signal and the input data corresponding to the rising edge of ENAB signal is displayed at the left end of the active area .

Parameter		symbol	Min.	Typ.	Max.	Unit	Remark
ENAB signal	Setup time	Tes	5	-	Tc-10	ns	
	Hold time	Teh	5	-	-	ns	
	Pulse width	Tep	10	512	512	clock	
Hsync-ENAB phase difference		THE	THp+1	148	TH-512	clock	

7-1-3. Vertical display position

The vertical display start position is the 35th line from the falling edge of Vsync .(cf. Fig.2-1 or 2-2)

7-2. ENAB mode (MODE = “High” or “Open”)

Timing diagrams of input signal are shown in Fig.3-1 (CKPOL = “Low”), Fig.3-2 (CKPOL = “High”)

7-2-1. Timing characteristics

Parameter		Symbol	Min.	Typ.	Max.	Unit
Clock A	Frequency	1/Tc	25	32.5	40	MHz
	Clock B	High time	Tch	9	-	-
Low time		Tcl	9	-	-	ns
Duty ratio		Tch/Tcl	0.67	1.00	1.50	
Phase difference		Tcp	-4	0	+4	ns
Data	Setup time	Tds	5	-	-	ns
	Hold time	Tdh	5	-	-	ns
Data enable signal	Setup time	Tes	5	-	Tc-10	ns
	Hold time	Teh	5	-	-	ns
	Horizontal period	TH	16.6	20.7	-	μs
			528	672	860	clock
	Horizontal period (High)	THp	10	512	512	clock
	Vertical period	TV	770	806	990	line
	Vertical blanking width	TVb	2	38	222	line

【Note】 In case of using the long vertical period, the deterioration of display quality, flicker etc., may be occurred.

7-3. Input Data Signals and Display Position on the screen

Graphics and texts can be displayed on a 1024 × 3 × 768 dots panel with 262,144 colors by supplying 36 bit data signal (6bit/color [64 gray scale] x 3 x 2 pixels) .

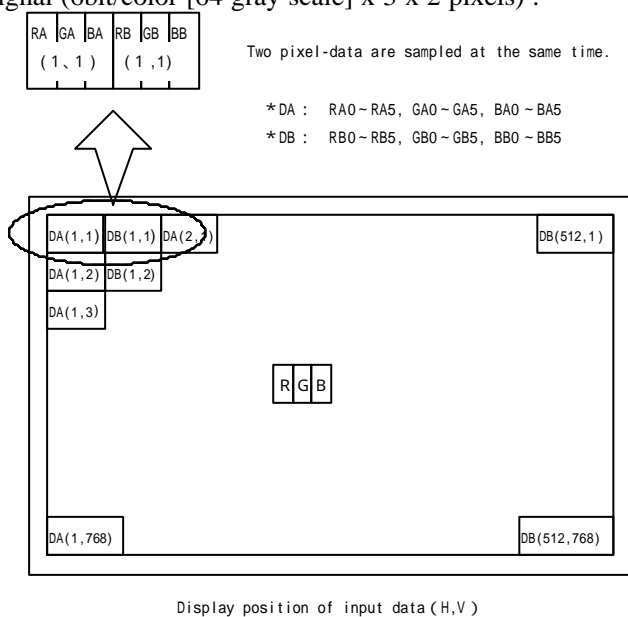

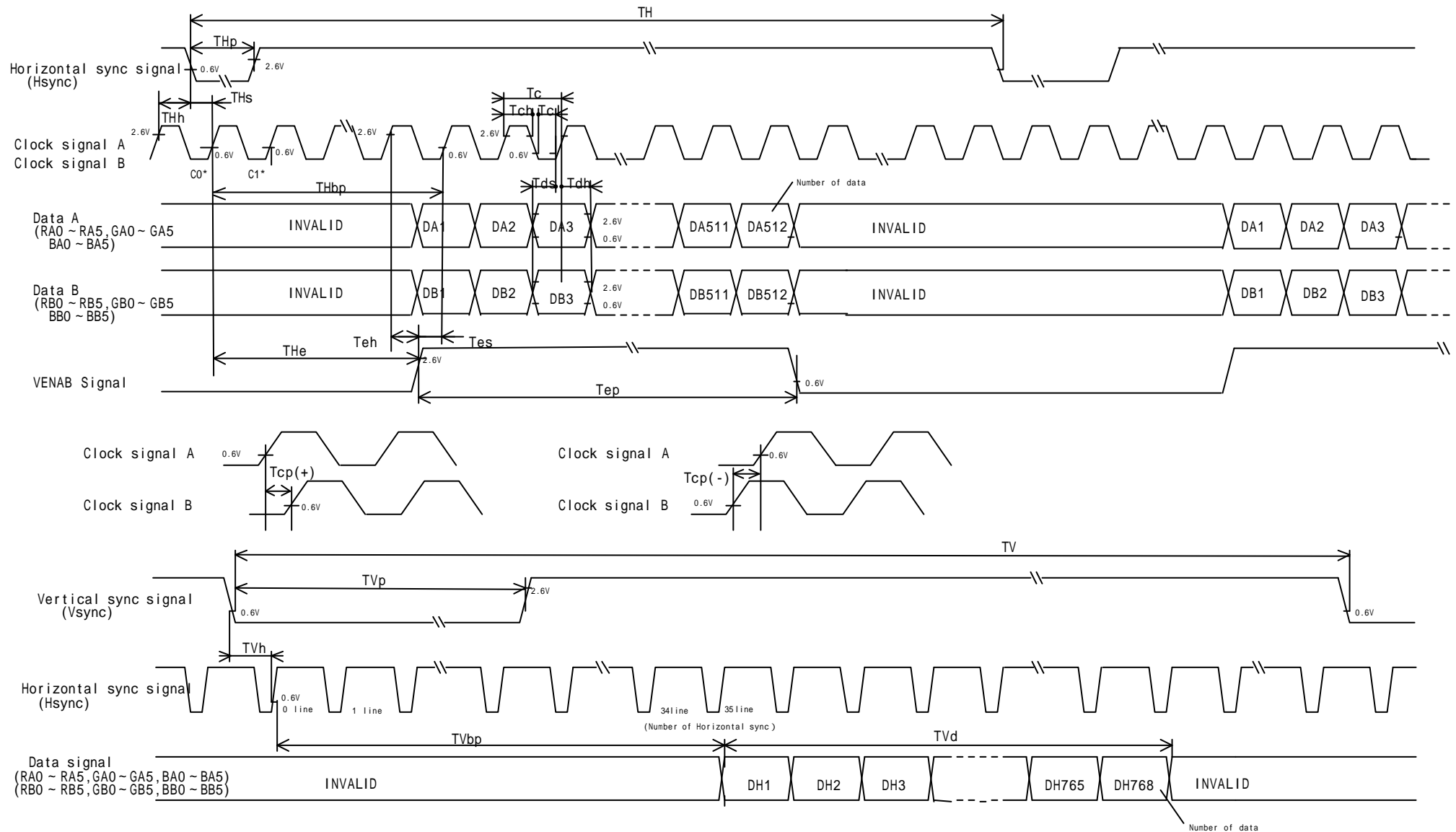

Fig.2-1 Input Signal Waveforms(H-V Mode,CKPOL= " Low ")

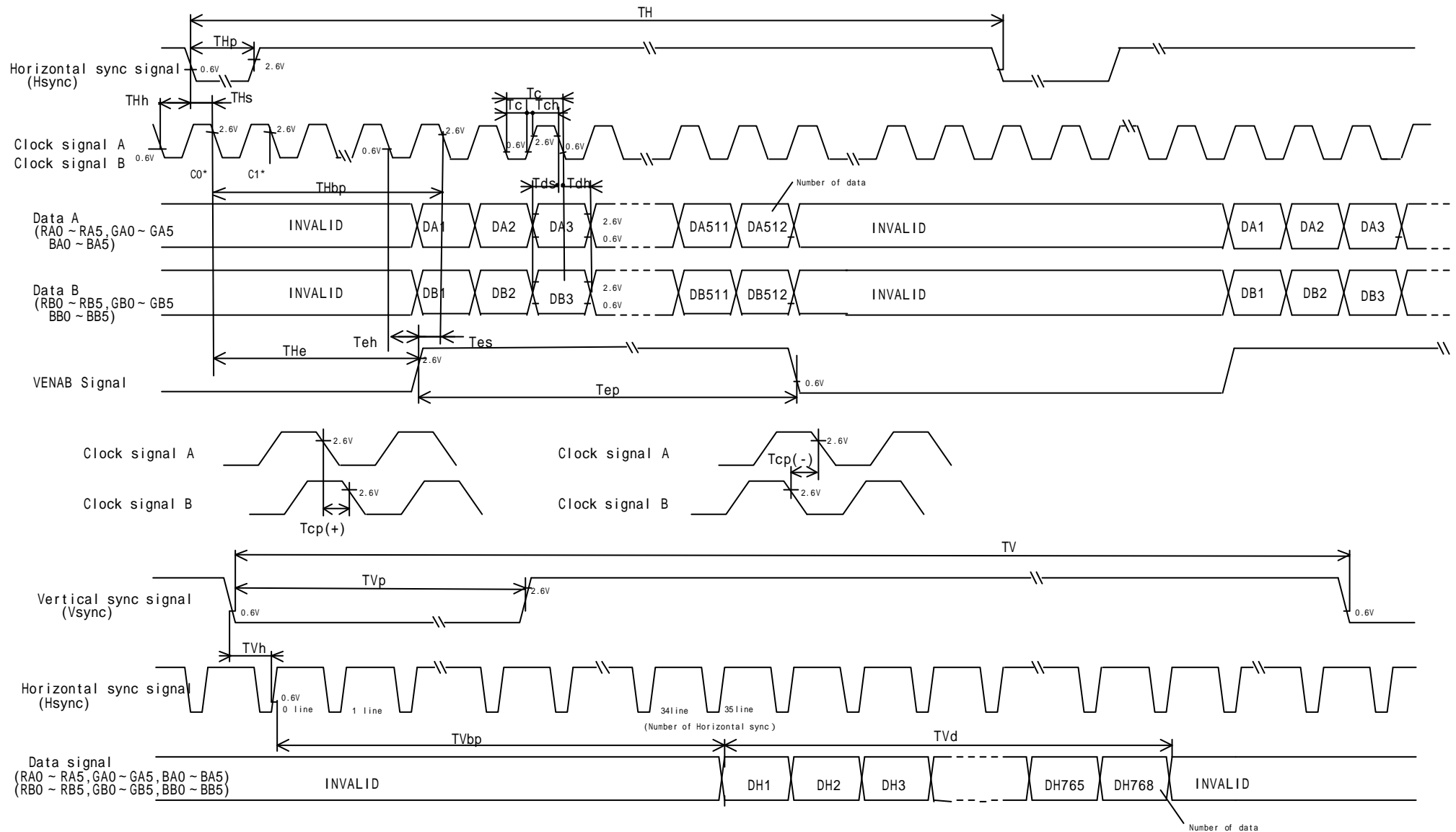

Fig.2-2 Input Signal Waveforms(H-V Mode,CKPOL= " High ")

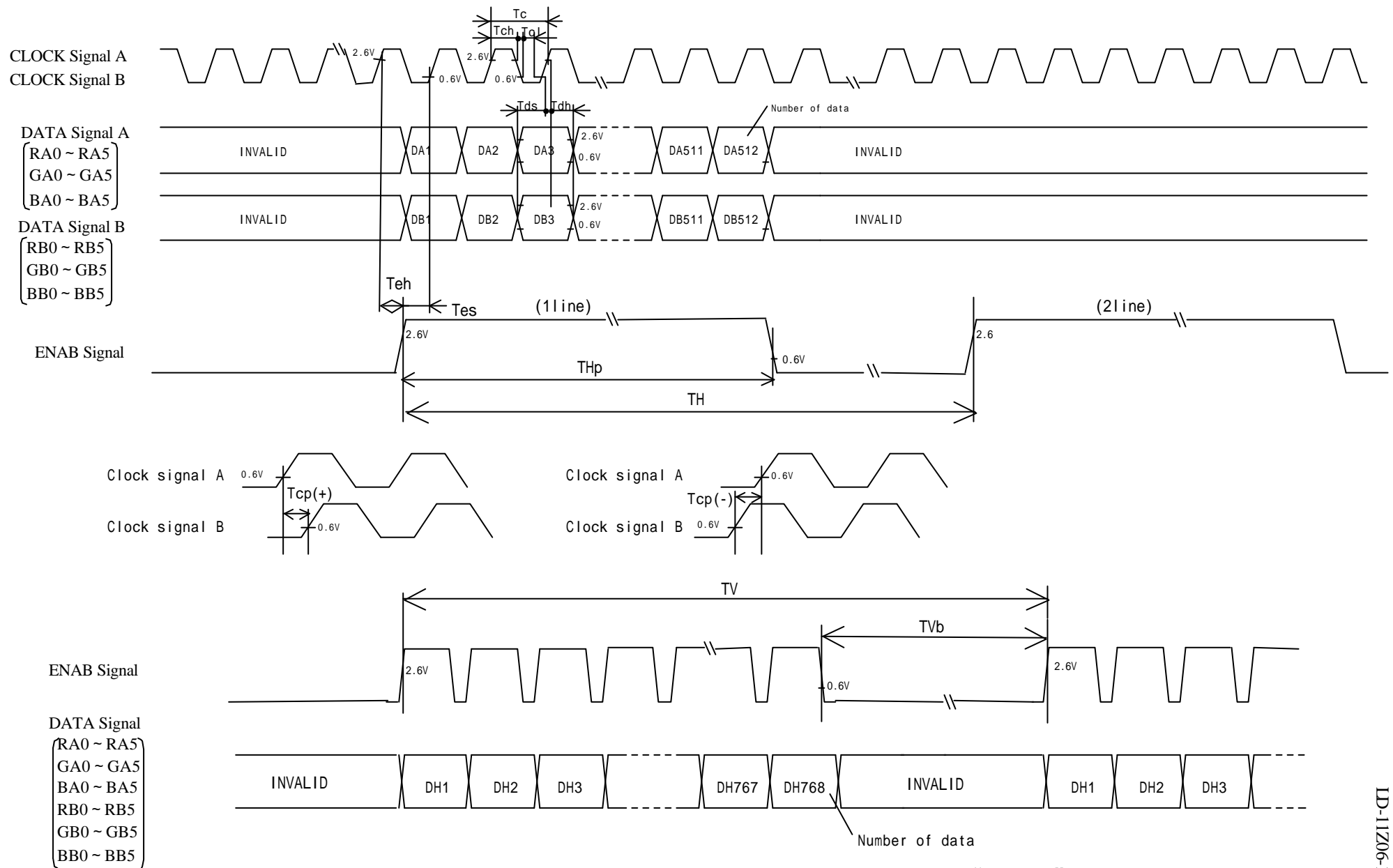

Fig.3-1 Input Signal Waveforms(ENAB mode,CKPOL= " Low ")

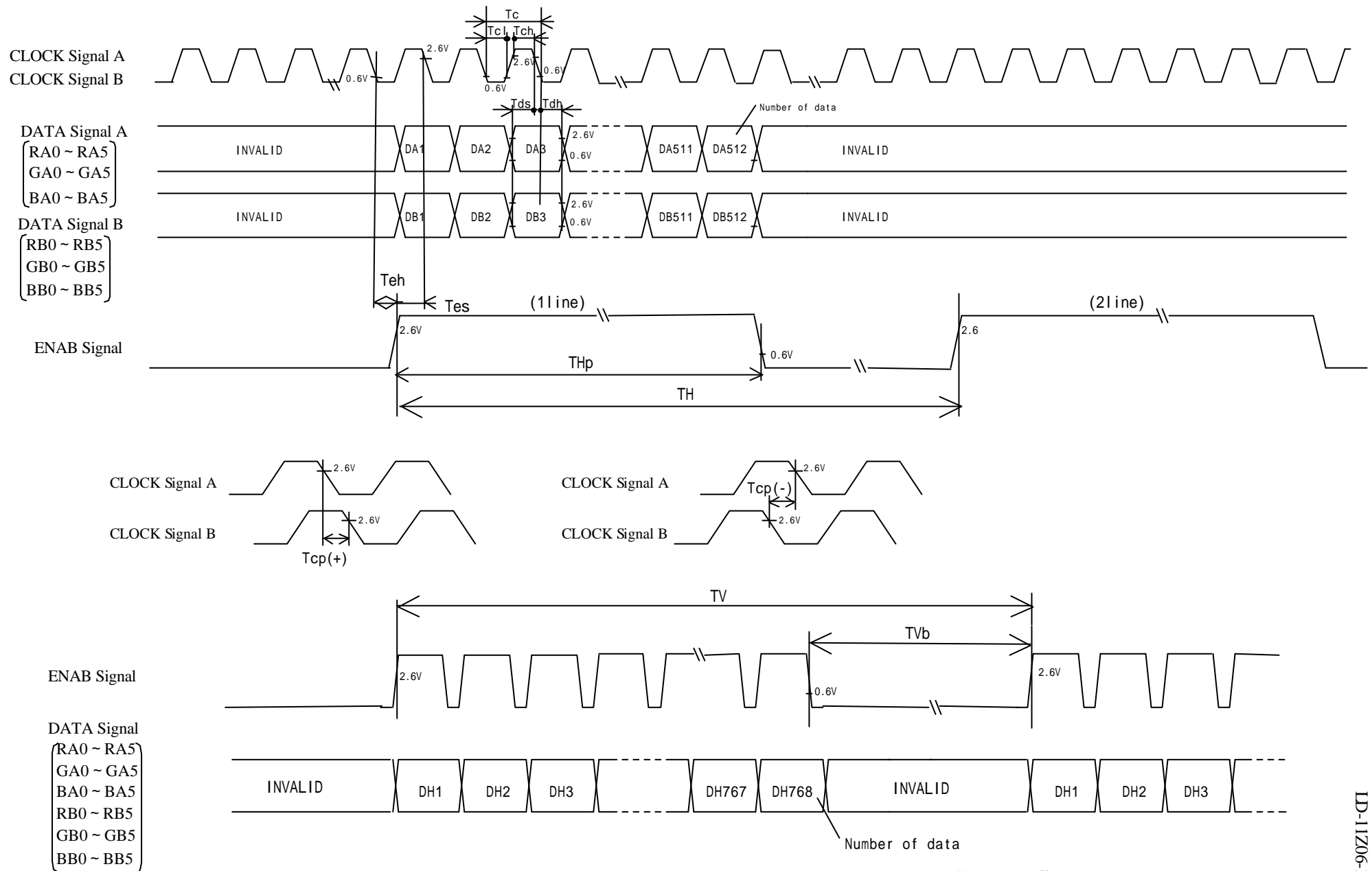

Fig.3-2 Input Signal Waveforms(ENAB mode,CKPOL= " High ")

8. Input Signals, Basic Display Colors and Gray Scale of Each Color

	Colors & Gray scale	Data signal																		
		Gray Scale	RA0	RA1	RA2	RA3	RA4	RA5	GA0	GA1	GA2	GA3	GA4	GA5	BA0	BA1	BA2	BA3	BA4	BA5
			RB0	RB1	RB2	RB3	RB4	RB5	GB0	GB1	GB2	GB3	GB4	GB5	BB0	BB1	BB2	BB3	BB4	BB5
Basic Color	Black	-	0	0	0	0	0	0	0	0	0	0	0	0	0	0	0	0	0	0
	Blue	-	0	0	0	0	0	0	0	0	0	0	0	0	1	1	1	1	1	1
	Green	-	0	0	0	0	0	0	1	1	1	1	1	1	0	0	0	0	0	0
	Cyan	-	0	0	0	0	0	0	1	1	1	1	1	1	1	1	1	1	1	1
	Red	-	1	1	1	1	1	1	0	0	0	0	0	0	0	0	0	0	0	0
	Magenta	-	1	1	1	1	1	1	0	0	0	0	0	0	1	1	1	1	1	1
	Yellow	-	1	1	1	1	1	1	1	1	1	1	1	1	0	0	0	0	0	0
	White	-	1	1	1	1	1	1	1	1	1	1	1	1	1	1	1	1	1	1
Gray Scale of Red	Black	GS0	0	0	0	0	0	0	0	0	0	0	0	0	0	0	0	0	0	0
	↑	GS1	1	0	0	0	0	0	0	0	0	0	0	0	0	0	0	0	0	0
	Darker	GS2	0	1	0	0	0	0	0	0	0	0	0	0	0	0	0	0	0	0
	↑	↓				↓					↓							↓		
	↓	↓				↓					↓							↓		
	Brighter	GS61	1	0	1	1	1	1	0	0	0	0	0	0	0	0	0	0	0	0
	↓	GS62	0	1	1	1	1	1	0	0	0	0	0	0	0	0	0	0	0	0
	Red	GS63	1	1	1	1	1	1	0	0	0	0	0	0	0	0	0	0	0	0
Gray Scale of Green	Black	GS0	0	0	0	0	0	0	0	0	0	0	0	0	0	0	0	0	0	0
	↑	GS1	0	0	0	0	0	0	1	0	0	0	0	0	0	0	0	0	0	0
	Darker	GS2	0	0	0	0	0	0	0	1	0	0	0	0	0	0	0	0	0	0
	↑	↓				↓					↓							↓		
	↓	↓				↓					↓							↓		
	Brighter	GS61	0	0	0	0	0	0	1	0	1	1	1	1	0	0	0	0	0	0
	↓	GS62	0	0	0	0	0	0	0	1	1	1	1	1	0	0	0	0	0	0
	Green	GS63	0	0	0	0	0	0	1	1	1	1	1	1	0	0	0	0	0	0
Gray Scale of Blue	Black	GS0	0	0	0	0	0	0	0	0	0	0	0	0	0	0	0	0	0	0
	↑	GS1	0	0	0	0	0	0	0	0	0	0	0	0	1	0	0	0	0	0
	Darker	GS2	0	0	0	0	0	0	0	0	0	0	0	0	0	1	0	0	0	0
	↑	↓				↓					↓							↓		
	↓	↓				↓					↓							↓		
	Brighter	GS61	0	0	0	0	0	0	0	0	0	0	0	0	1	0	1	1	1	1
	↓	GS62	0	0	0	0	0	0	0	0	0	0	0	0	0	1	1	1	1	1
	Blue	GS63	0	0	0	0	0	0	0	0	0	0	0	0	1	1	1	1	1	1

0 : Low level voltage, 1 : High level voltage

Each basic color can be displayed in 64 gray scales from 6 bit data signals. According to the combination of total 18 bit data signals, the 262,144-color display can be achieved on the screen.

9. Optical Characteristics

Ta=25 , Vcc=+5V

Parameter	Symbol	Condition	Min.	Typ.	Max.	Unit	Remark		
Viewing angle range	Horizontal	21, 22	CR 5	60	70	-	Deg.	【Note1,4】	
	Vertical	11		45	60	-	Deg.		
		12		50	60	-	Deg.		
	Horizontal	21, 22	CR 10	50	65	-	Deg.	【Note1,4】	
		Vertical		11	35	50	-		Deg.
				12	40	50	-		Deg.
Contrast ratio		C R n	=0 °	200	300	-		【Note2,4】	
Response time	Rise	r		-	10	25	m s	【Note3,4】	
	Decay	d		-	35	50	m s		
Chromaticity of white		x		0.283	0.313	0.343		【Note4】	
		y		0.299	0.329	0.359			
Luminance of white		Y _{L1}		180	220	-	cd/m ²	I _L =6.0mArms 【Note4】	
White Uniformity		w	-	-	1.35		【Note5】		

The measurement shall be executed 30 minutes after lighting at rating .

(typical condition:I_L=6.0mArms)

The optical characteristics shall be measured in a dark room or equivalent state with the method shown in Fig.6 below .

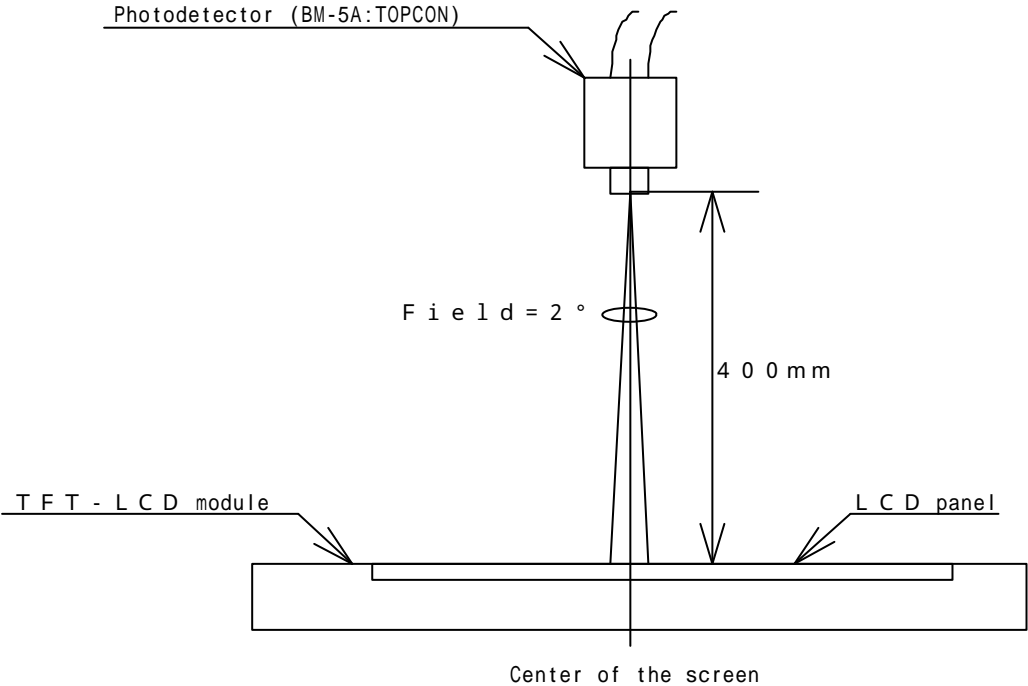
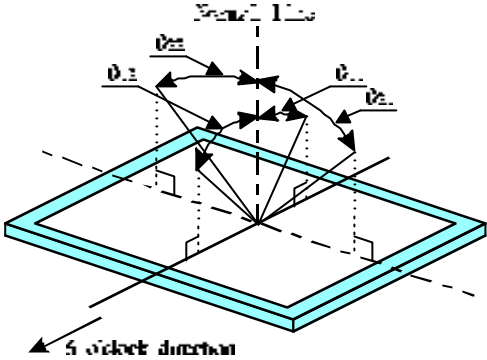

Fig.4 Optical characteristics measurement method

【Note1】 Definitions of viewing angle range:



【Note2】 Definition of contrast ratio:

The contrast ratio is defined as the following .

$$\text{Contrast Ratio (CR)} = \frac{\text{Luminance (brightness) with all pixels white}}{\text{Luminance (brightness) with all pixels black}}$$

【Note3】 Definition of response time:

The response time is defined as the following figure and shall be measured by switching the input signal for "black" and "white" .

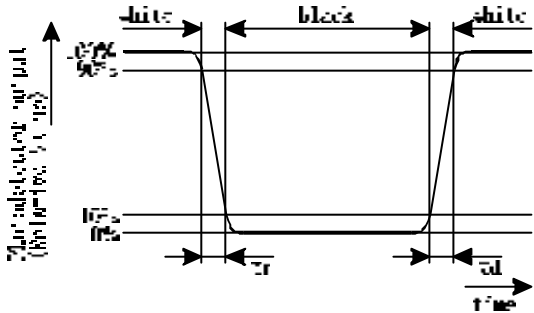

【Note4】 This shall be measured at center of the screen .

【Note5】 Definition of white uniformity:

White uniformity is defined as the following with five measurements (A ~ E) .

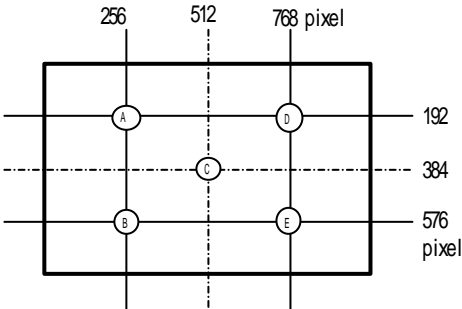

$$w = \frac{\text{Maximum Luminance of five points (brightness)}}{\text{Minimum Luminance of five points (brightness)}}$$

10. Handling Precautions

- a) Be sure to turn off the power supply when inserting or disconnecting the cable .
- b) Be sure to design the cabinet so that the module can be installed without any extra stress such as warp or twist .
- c) Since the front polarize is easily damaged, pay attention not to scratch it .
- d) Since long contact with water may cause discoloration or spots, wipe off water drop immediately .
- e) When the panel surface is soiled, wipe it with absorbent cotton or other soft cloth. .
- f) Since the panel is made of glass, it may break or crack if dropped or bumped on hard surface. Handle with care .
- g) Since CMOS LSI is used in this module, take care of static electricity and take the human earth into consideration when handling .
- h) Make sure the four mounting holes of the module are grounded sufficiently. Take electro-magnetic interference (EMI) into consideration.
- i) The module has some printed circuit boards (PCBs) on the back side. Take care to keep them form any stress or pressure when handling or installing the module; otherwise some of electronic parts on the PCBs may be damaged.
- j) Observe all other precautionary requirements in handling components.
- k) When some pressure is added onto the module from rear side constantly , it causes display non-uniformity issue , functional defect , etc . So , please avoid such design.
- l) When handling LCD modules and assembling them into cabinets, please be noted that long-term storage in the environment of oxidization or deoxidization gas and the use of such materials as reagent, solvent, adhesive, resin, etc. which generate these gasses, may cause corrosion and discoloration of the LCD modules.

11. Packing form 4

	Form	Form
Product country	JAPAN	TAIWAN
Piling number of cartons	5 cartons	5 cartons
Packing quantity in one carton	5 modules	5 modules
Carton size [mm]	410 (W) × 500 (D) × 240 (H)	420 (W) × 510 (D) × 225 (H)
Total mass of one carton filled with full modules	8 9 5 0 g	9 3 0 0 g
Packing form is shown	Fig .5	Fig .6

Carton storage condition

Temperature	0 to 40
Humidity	95%RH or less
Reference condition :	20 to 35 , 85%RH or less (summer) : 5 to 15 , 85%RH or less (winter) • the total storage time (40 ,95%RH) : 240H or less
Sunlight	Be sure to shelter a product from the direct sunlight.
Atmosphere	Harmful gas, such as acid and alkali which bites electronic components and/or wires, must not be detected.
Notes	Be sure to put cartons on palette or base, don't put it on floor, and store them with removing from wall. Please take care of ventilation in storehouse and around cartons, and control changing temperature is within limits of natural environment.
Storage period	1 year

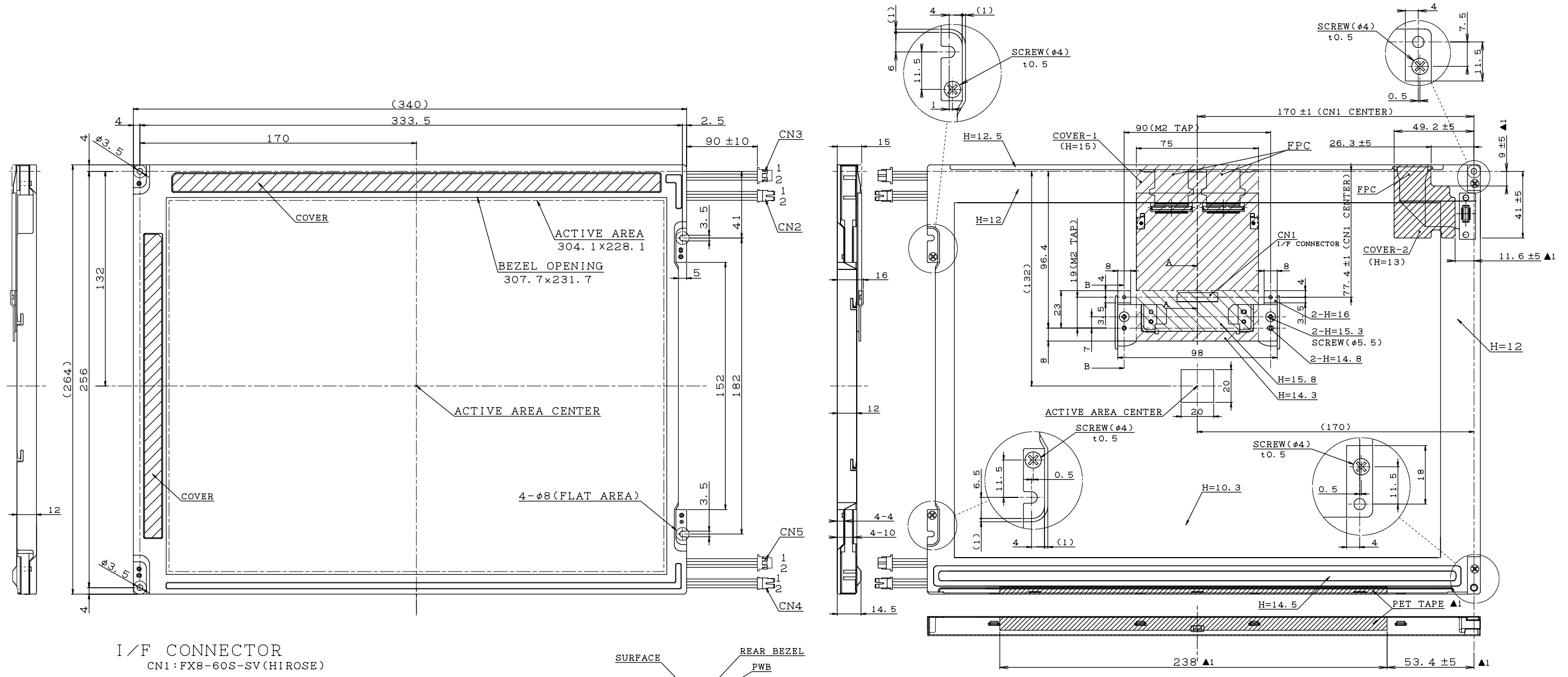

I/F CONNECTOR
CN1 : FX8-60S-SV (HIROSE)

CCFT CONNECTOR
CN3, 5 : BHR-02VS-1 (JST) CN2, 4 : BHSR-02VS-1 (JST)
PIN LAYOUT PIN LAYOUT

1	Low-1
2	Low-2

1	High-1
2	High-2

NOTES

1. UNSPECIFIED TOLERANCE TO BE ± 0.5
2. WARP AND FLATING FOR PCB AND CHASSIS ARE EXCLUDED FROM THICKNESS AND DIMENSION OF THE UNIT.
3. ELECTRONIC PARTS ARE ARRANGED UNDER COVER. (HATCHING AREA) PLEASE DO NOT PRESS.

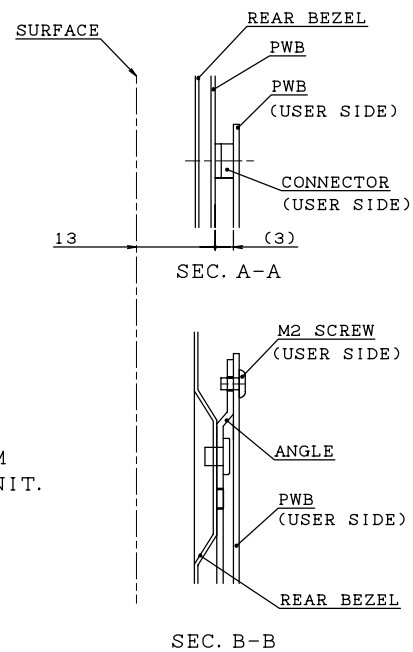

DETAILS OF MASKING/BM SLIT POSITION

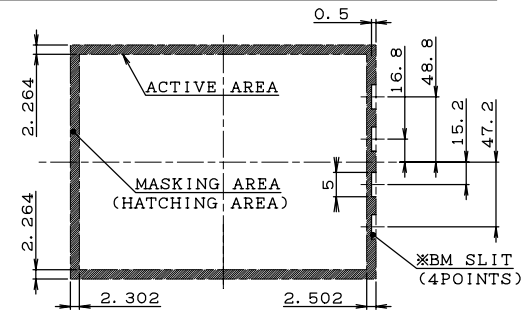

NOTE: THERE IS BM SLIT AT THE ABOVE MENTIONED POSITION AT THE RIGHT SIDE OF MODULE.

BM SLIT: THE POSITION LOOKED DIFFERENT COLOR (LIKE BROWN) AT THE MASKING PORTION. THERE IS NO LIGHT LEAKAGE AT THE SLIT. (BM IS AN ABBREVIATION OF BLACK MASK)

BEZEL/DISPLAY POSITION

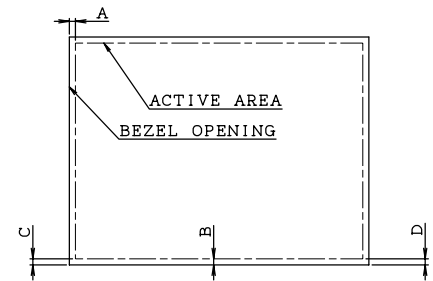

- 1) TOLERANCE X-DIRECTION A: 1.8 ± 0.8
- 2) TOLERANCE Y-DIRECTION B: 1.8 ± 0.8
- 3) OBLIQUITY OF DISPLAY AREA $|C-D| < 0.8$

Fig. 1 OUTLINE DIMENSIONS (LQ150X1DG51)

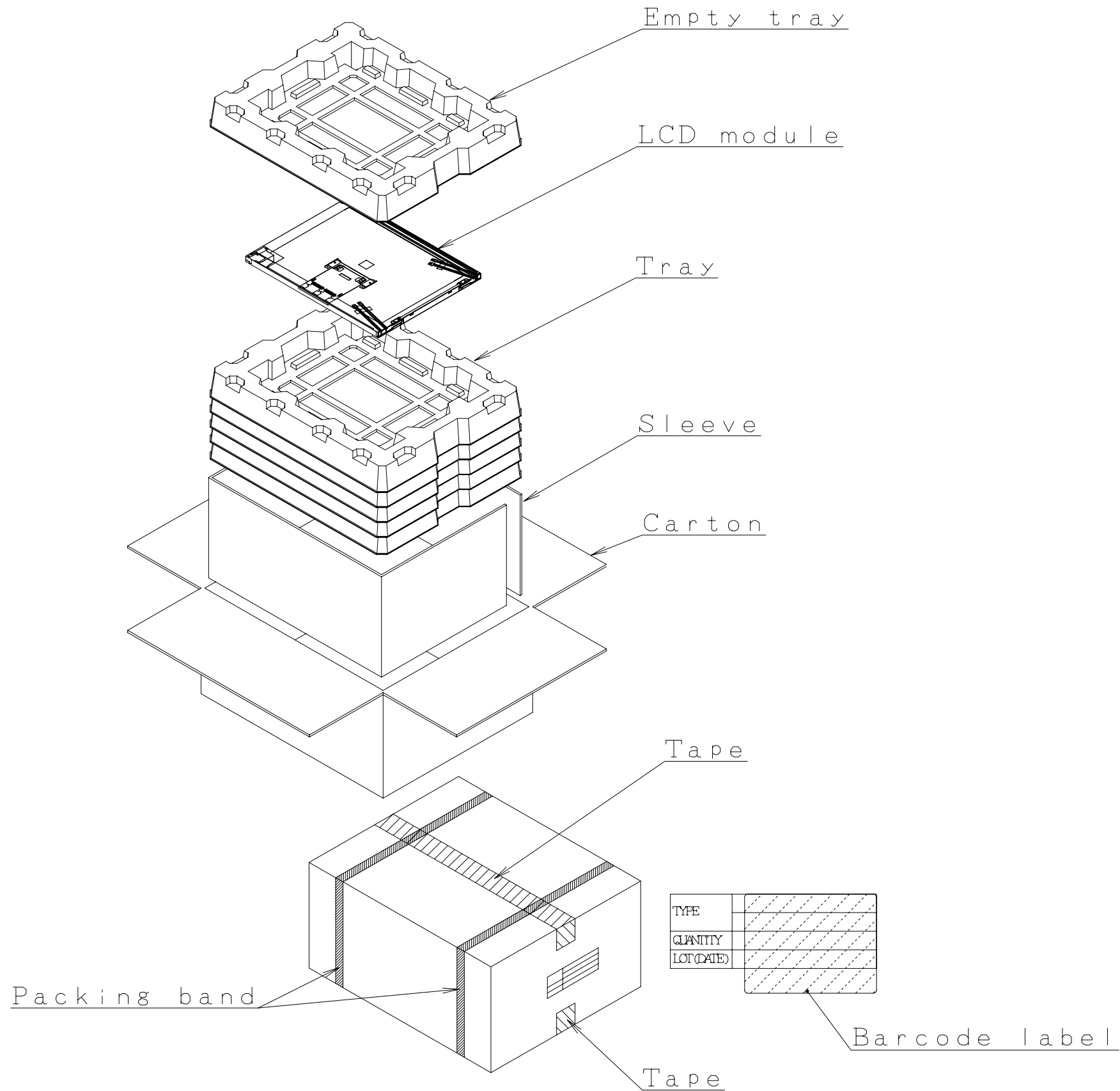

社内品番: (4S)LQ150X1DG51	← ①
<input type="text"/>	
LotNO. : (1T)1999.12.10 1	← ②
<input type="text"/>	
Quantity: (Q) 5 pcs	← ③
<input type="text"/>	
ユーザー品番 :	← ④
<input type="text"/>	
シャープ物流用ラベルです。	← ⑤

- ① Model No.
- ② Lot No. (Date)
- ③ Quantity
- ④ User model No.
- ⑤ Sharp model No.

Fig. 5 PACKING FORM①(LQ150X1DG51)

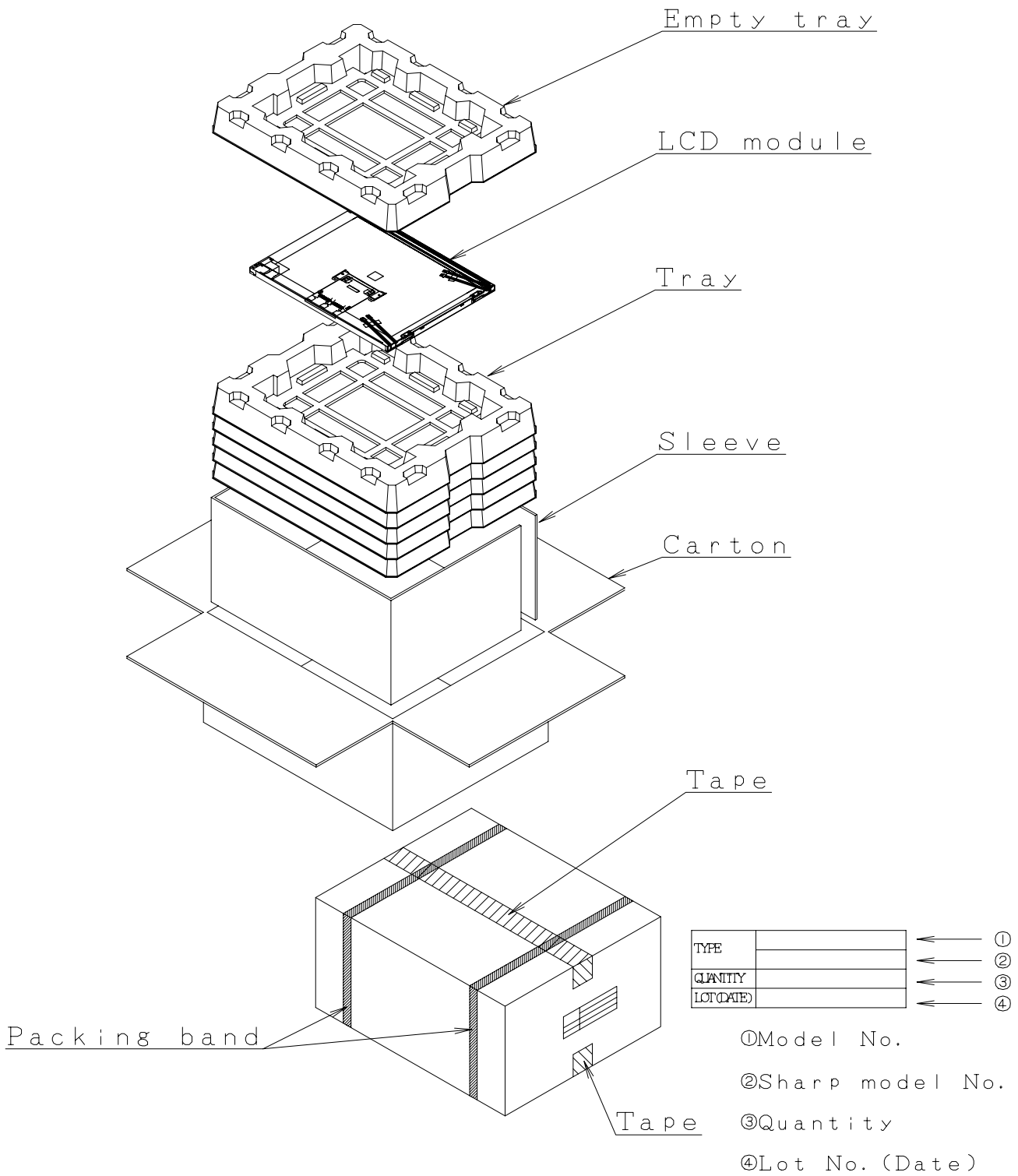

Fig. 6 PACKING FORM②(LQ150X1DG51) 4