

PRELIMINARY

NEC NEC LCD Technologies, Ltd.

TFT COLOR LCD MODULE

NL8060BC31-32

**30.8cm (12.1 Type)
SVGA**

PRELIMINARY DATA SHEET 

DOD-PD-0647 (2nd edition)

**This PRELIMINARY DATA SHEET is updated
document from DOD-PD-0595(1).**

**All information is subject to change without notice.
Please confirm the sales representative before
starting to design your system.**

INTRODUCTION

No part of this document shall be copied in any form or by any means without the prior written consent of NEC LCD Technologies, Ltd. (hereinafter called "NEC").

NEC does not assume any liability for infringement of patents, copyrights or other intellectual property rights of third parties by or arising from use of a product described herein or any other liability arising from use of such application. No license, express, implied or otherwise, is granted under any patents, copyrights or other intellectual property rights of NEC or of others.

While NEC has been making continuous effort to enhance the reliability of its products, the possibility of failures cannot be eliminated entirely. To minimize risks of damage to property or injury to person arising from a failure in an NEC product, customers must incorporate sufficient safety measures in their design, such as redundancy, fire-containment and anti-failure features.

NEC products are classified into the following three quality grades:

"Standard", "Special", "Specific"

The *"Specific"* quality grade applies only to applications developed based on a customer designated "quality assurance program" for a specific application. The recommended applications of a product depend on its quality grade, as indicated below. Customers must check the quality grade of each application before using it in a particular application.

Standard: Computers, office equipment, communications equipment, test and measurement equipment, audio and visual equipment, home electronic appliances, machine tools, personal electronic equipment and industrial robots

Special: Transportation equipment (automobiles, trains, ships, etc.), traffic control systems, anti-disaster systems, anti-crime systems, safety equipment and medical equipment (not specifically designed for life support)

Specific: Military systems, aircraft, aerospace equipment, submersible repeaters, nuclear reactor control systems, life support systems (medical equipment, etc.) and any other equipment

The quality grade of this product is *"Standard"* unless otherwise specified in this document. If customers intend to use this product for applications other than those specified for *"Standard"* quality grade, they should contact NEC sales representative in advance.

CONTENTS

INTRODUCTION	2
1. OUTLINE.....	4
1.1 STRUCTURE AND PRINCIPLE.....	4
1.2 APPLICATION.....	4
1.3 FEATURES.....	4
2. GENERAL SPECIFICATIONS	5
3. BLOCK DIAGRAM.....	6
4. DETAILED SPECIFICATIONS	7
4.1 MECHANICAL SPECIFICATIONS.....	7
4.2 ABSOLUTE MAXIMUM RATINGS	7
4.3 ELECTRICAL CHARACTERISTICS	8
4.3.1 LCD panel signal processing board	8
4.3.2 Backlight lamp.....	9
4.3.3 Power supply voltage ripple.....	10
4.3.4 Fuse.....	10
4.4 POWER SUPPLY VOLTAGE SEQUENCE	11
4.4.1 LCD panel signal processing board	11
4.4.2 Inverter (Option).....	11
4.5 CONNECTIONS AND FUNCTIONS FOR INTERFACE PINS.....	12
4.5.1 LCD panel signal processing board	12
4.5.2 Backlight lamp.....	13
4.5.3 Positions of plugs and a socket	13
4.6 DISPLAY COLORS AND INPUT DATA SIGNALS	14
4.7 DISPLAY POSITIONS.....	15
4.8 SCANNING DIRECTIONS	15
4.9 INPUT SIGNAL TIMINGS.....	16
4.9.1 Outline of input signal timings	16
4.9.2 Timing characteristics	17
4.9.3 Input signal timing chart.....	19
4.10 OPTICS.....	22
4.10.1 Optical characteristics transmissive mode	22
4.10.2 Definition of contrast ratio.....	23
4.10.3 Definition of luminance uniformity	23
4.10.4 Definition of response times	23
4.10.5 Definition of viewing angles.....	23
4.10.6 Optical characteristics for reflective mode	24
5. RELIABILITY TESTS.....	25
6. PRECAUTIONS	26
6.1 MEANING OF CAUTION SIGNS	26
6.2 CAUTIONS	26
6.3 ATTENTIONS	26
6.3.1 Handling of the product	26
6.3.2 Environment.....	27
6.3.3 Characteristics.....	27
6.3.4 Other	27
7. OUTLINE DRAWINGS	28
7.1 FRONT VIEW	28
7.2 REAR VIEW	29
REVISION HISTORY	30

1. OUTLINE

1.1 STRUCTURE AND PRINCIPLE

Color LCD module NL8060BC31-32 is composed of the amorphous silicon thin film transistor liquid crystal display (a-Si TFT LCD) panel structure with driver LSIs for driving the TFT (Thin Film Transistor) array and a backlight.

The a-Si TFT LCD panel structure is injected liquid crystal material into a narrow gap between the TFT array glass substrate and a color-filter glass substrate.

Color (Red, Green, Blue) data signals from a host system (e.g. PC, signal generator, etc.) are modulated into best form for active matrix system by a signal processing circuit, and sent to the driver LSIs which drive the individual TFT arrays.

The TFT array as an electro-optical switch regulates the amount of transmitted light from the backlight assembly, when it is controlled by data signals. Color images are created by regulating the amount of transmitted light through the TFT array of red, green and blue dots.

1.2 APPLICATION

- For industrial use

1.3 FEATURES

- Transflective type LCD
- High luminance
- High contrast
- Wide viewing angle
- Wide temperature range
- 6-bit digital RGB signals
- Reversible-scan direction
- Edge light type (without inverter)
- Replaceable lamp for backlight

PRELIMINARY

2. GENERAL SPECIFICATIONS

2

Display area	246.0 (H) × 184.5 (V) mm
Diagonal size of display	30.8 cm (12.1 inches)
Drive system	a-Si TFT active matrix
Display color	262,144 colors
Pixel	800 (H) × 600 (V) pixels
Pixel arrangement	RGB (Red dot, Green dot, Blue dot) vertical stripe
Dot pitch	0.1025 (H) × 0.3075 (V) mm
Pixel pitch	0.3075 (H) × 0.3075 (V) mm
Module size	280.0 (W) × 210.0 (H) × 13.0 (D) mm (typ.)
Weight	740 g (typ.)
Contrast ratio	At transmissive mode 600:1 (typ.)
Viewing angle	At transmissive mode and the contrast ratio ≥ 10:1 <ul style="list-style-type: none"> • Horizontal: Right side 70° (typ.), Left side 70° (typ.) • Vertical: Up side 45° (typ.), Down side 55° (typ.)
Designed viewing direction	At transmissive mode and DPS= Low or Open: Normal scan <ul style="list-style-type: none"> • Viewing direction without image reversal: up side (12 o'clock) • Viewing direction with contrast peak: down side (6 o'clock) • Viewing angle with optimum grayscale ($\gamma=2.2$): normal axis
Polarizer surface	Clear + Antireflection (AR)
Polarizer pencil-hardness	3H (min.) [by JIS K5400]
Color gamut	At transmissive mode and LCD panel center 40 % (typ.) [against NTSC color space]
Response time	At transmissive mode, Ton+Toff (10%←→90%) 33 ms (typ.)
Luminance	At transmissive mode and IBL= 5.0mArms / lamp 400 cd/m ² (typ.)
Reflectance	At reflective mode 2.0 % (typ., reference)
Signal system	6-bit digital signals for data of RGB colors, Dot clock (CLK), Data enable (DE), Horizontal synchronous signal (Hsync), Vertical synchronous signal (Vsync)
Power supply voltage	LCD panel signal processing board: 3.3V or 5.0V
Backlight	Edge light type: 2 cold cathode fluorescent lamps (Replaceable part • Lamp holder set: Type No. 121LHS18) (Recommended inverter (Option) • Inverter: Type No. 121PW181)
Power consumption	At IBL=5.0mArms / lamp and checkered flag pattern 6.4 W (typ., Power dissipation of the inverter is not included.)

3. BLOCK DIAGRAM

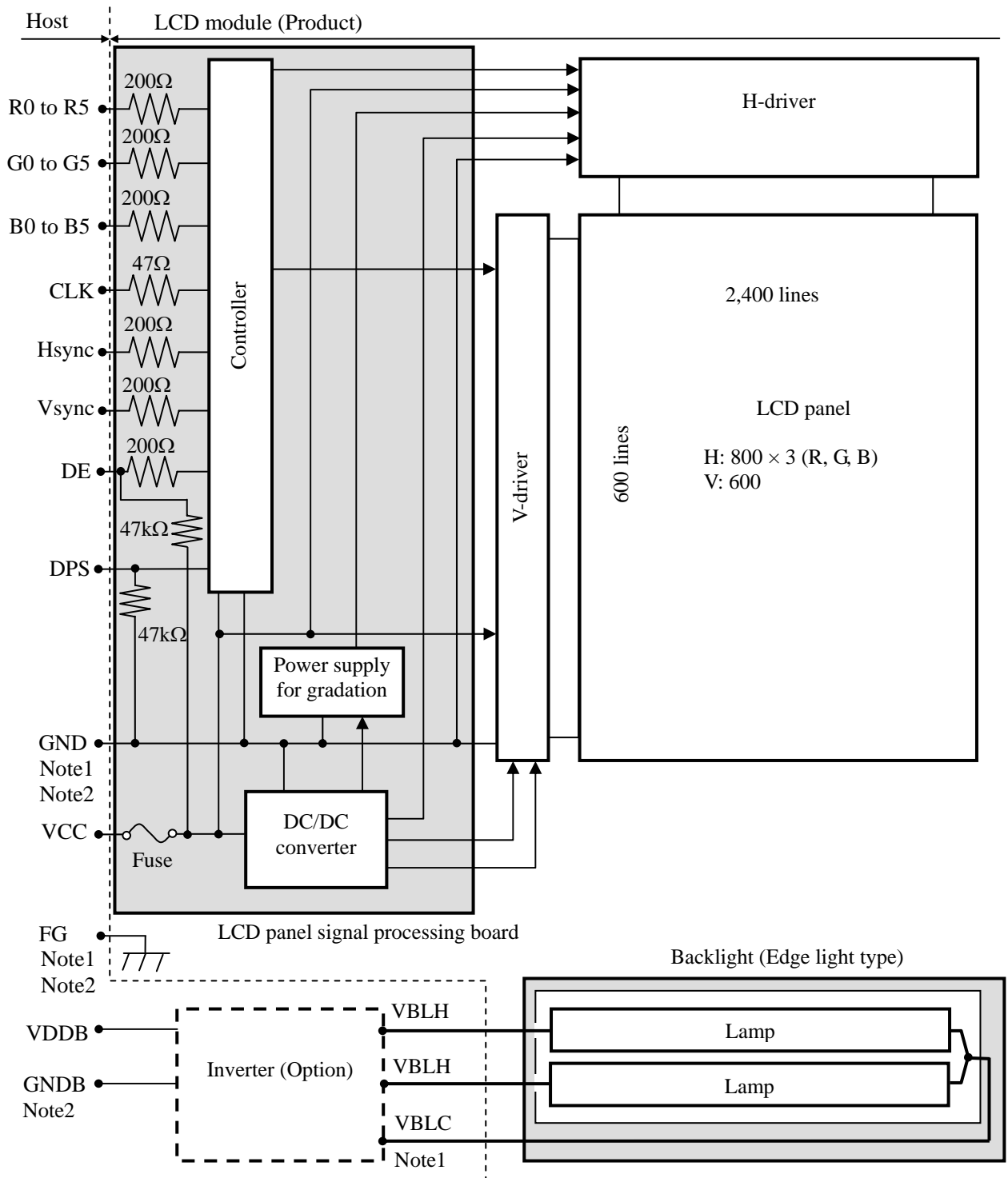

Note1: Connections between GND (Signal ground), FG (Frame ground) and VBLC (Lamp low voltage terminal) in the LCD module

GND - FG	Not connected
GND - VBLC	Not connected
FG - VBLC	Not connected

Note2: GND, FG and GNDB must be connected to customer equipment's ground, and it is recommended that these grounds are connected together in customer equipment.

PRELIMINARY

4. DETAILED SPECIFICATIONS

4.1 MECHANICAL SPECIFICATIONS

Parameter	Specification	Unit
Module size	280.0 ± 0.5 (W) × 210.0 ± 0.5 (H) × 13.0 (typ., D) 13.7 (max., D) Note1	mm
Display area	246.0 (H) × 184.5 (V) Note1	mm
Weight	740 (typ.), 770 (max.)	g

Note1: See "7. OUTLINE DRAWINGS".

2

4.2 ABSOLUTE MAXIMUM RATINGS

Parameter		Symbol	Rating	Unit	Remarks
Power supply voltage	LCD panel signal processing board	VCC	-0.3 to +6.5	V	Ta = 25°C
	Lamp voltage	VBLH	1,800	Vrms	
Input voltage for signals	Display signals Note1	VD	-0.3 to VCC+0.3	V	
	Function signal Note2	VF			
Incident light intensity		II	150,000	lx	Note3
Storage temperature		Tst	-20 to +80	°C	-
Operating temperature	Front surface	TopF	-10 to +70	°C	Note4
	Rear surface	TopR	-10 to +70	°C	Note5
Relative humidity Note6		RH	≤ 95	%	Ta ≤ 40°C
			≤ 85	%	40 < Ta ≤ 50°C
Absolute humidity Note6		AH	≤ 70 Note7	g/m ³	Ta > 50°C

Note1: CLK, Hsync, Vsync, DE, R0 to R5, G0 to G5, B0 to B5

Note2: DPS

Note3: If an ultraviolet ray is directly irradiated to the product surface (polarizer), the polarizer may discolor (Surface treatment may be damaged.). Use a filter to protect the polarizer from the ultraviolet ray.

Note4: Measured at center of LCD panel surface (including self-heat)

Note5: Measured at center of LCD module's rear shield surface (including self-heat)

Note6: No condensation

Note7: Water amount at Ta = 50°C and RH = 85%

PRELIMINARY

4.3 ELECTRICAL CHARACTERISTICS

4.3.1 LCD panel signal processing board

(Ta = 25°C)

Parameter	Symbol	min.	typ.	max.	Unit	Remarks
Power supply voltage	VCC	3.0	3.3	3.6	V	at VCC = 3.3V
		4.75	5.0	5.25	V	at VCC = 5.0V
Power supply current	ICC	-	210 Note1	450 Note2	mA	at VCC = 3.3V
		-	140 Note1	300 Note2	mA	at VCC = 5.0V
Logic input voltage for display signals	High	V _{DH}	0.7V _{CC}	-	V _{CC}	CMOS level
	Low	V _{DL}	0	-	0.3V _{CC}	
Input voltage for DPS signal	High	V _{FH}	0.7V _{CC}	-	V _{CC}	
	Low	V _{FL}	0	-	0.3V _{CC}	

Note1: Checkered flag pattern [by EIAJ ED-2522]

Note2: Pattern for maximum current

4.3.2 Backlight lamp

(Ta=25°C, Note1)

Parameter	Symbol	min.	typ.	max.	Unit	Remarks
Lamp current	IBL	2.0	5.0	5.5	mArms	at IBL=5.0mArms: 400cd/m ² Note3, Note4
Lamp voltage	VBLH	-	570	-	Vrms	Note2, Note3
Lamp starting voltage	VS	970	-	-	Vrms	Ta = 25°C Note2, Note3
		1,410	-	-	Vrms	Ta = -10°C Note2, Note3
Lamp oscillation frequency	FO	58	63	68	kHz	Note5

Note1: This product consists of 2 backlight lamps, and these specifications are for each lamp.

Note2: The lamp voltage cycle between lamps should be kept on a same phase. "VS" and "VBLH" are the voltage value between low voltage side (Cold) and high voltage side (Hot).

Note3: The asymmetric ratio of working waveform for lamps (Power supply voltage peak ratio, power supply current peak ratio and waveform space ratio) should be less than 5 % (See the following figure.). If the waveform is asymmetric, DC (Direct current) element apply into the lamp. In this case, a lamp lifetime may be shortened, because a distribution of a lamp enclosure substance inclines toward one side between low voltage terminal (Cold terminal) and high voltage terminal (Hot terminal).

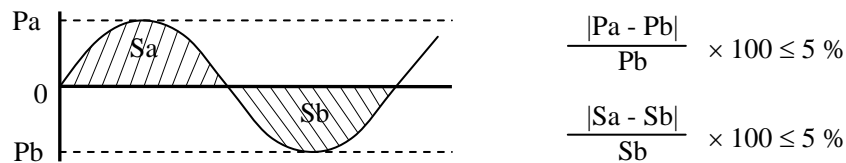

Pa: Supply voltage/current peak for positive, Pb: Supply voltage/current peak for negative
Sa: Waveform space for positive part, Sb: Waveform space for negative part.

Note4: This product consists of 2 lamps. 2 lamps are contained in the 1 lamp holder, and both lamps are connected to 1 low voltage cable. Recommendation lamp current is 5.0mArms typical for each lamp, and sum of 2 lamps is 10mArms typical. The lamp current should be measured by high-frequency current meter at the low voltage terminal.

Note5: In case "FO" is not the recommended value, beat noise may display on the screen, because of interference between "FO" and "1/th". Recommended value of "FO" is as following

$$FO = \frac{1}{4} \times \frac{1}{th} \times (2n-1)$$

th: Horizontal cycle (See "4.9.2 Timing characteristics".)

n: Natural number (1, 2, 3)

Note6: Method of lamp cable installation may invite fluctuation of lamp current and voltage or asymmetric of lamp working waveform. When designing method of lamp cable installation, evaluate the fluctuation of lamp current, voltage and working waveform sufficiently.

PRELIMINARY

4.3.3 Power supply voltage ripple

This product works, even if the ripple voltage levels are beyond the permissible values as following the table, but there might be noise on the display image.

Power supply voltage		Ripple voltage (Measure at input terminal of power supply)	Note1	Unit
VCC	3.3V	≤ 100		mVp-p
	5.0V	≤ 100		mVp-p

Note1: The permissible ripple voltage includes spike noise.

4.3.4 Fuse

Parameter	Fuse		Rating	Fusing current	Remarks
	Type	Supplier			
VCC	FCC16202AB	KAMAYA ELECTRIC Co., Ltd	2.0A	4.0A	Note1
			32V		

Note1: The power supply capacity should be more than the fusing current. If the power supply capacity is less than the fusing current, the fuse may not blow for a short time, and then nasty smell, smoking and so on may occur.

4.4 POWER SUPPLY VOLTAGE SEQUENCE

4.4.1 LCD panel signal processing board

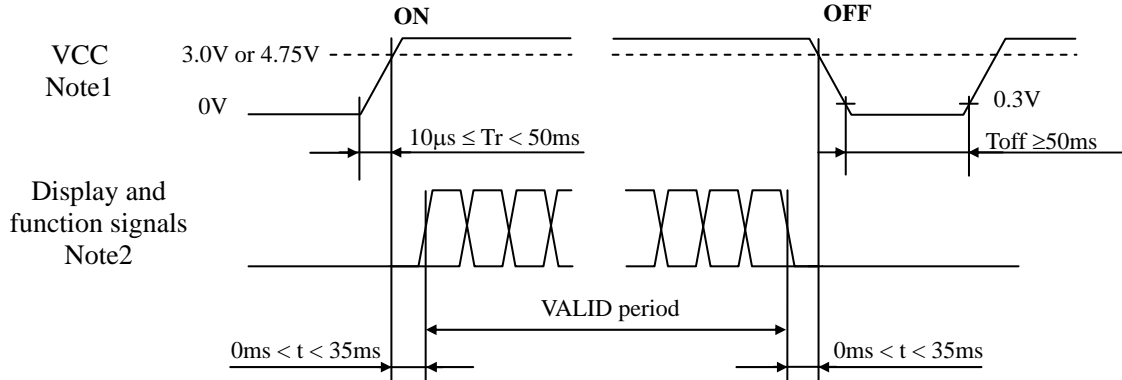

Note1: In terms of voltage variation (voltage drop) while VCC rising edge is below 3.0V in "VCC = 3.3V" or 4.75V in "VCC = 5.0V", a protection circuit may work, and then this product may not work.

Note2: Display signals (CLK, Hsync, Vsync, DE, R0 to R5, G0 to G5, B0 to B5) and function signal (DPS) must be Low or High-impedance, exclude the VALID period (See above sequence diagram), in order to avoid that internal circuits is damaged.

If some of display and function signals of this product are cut while this product is working, even if the signal input to it once again, it might not work normally. If customer stops the display and function signals, they should be cut VCC.

4.4.2 Inverter (Option)

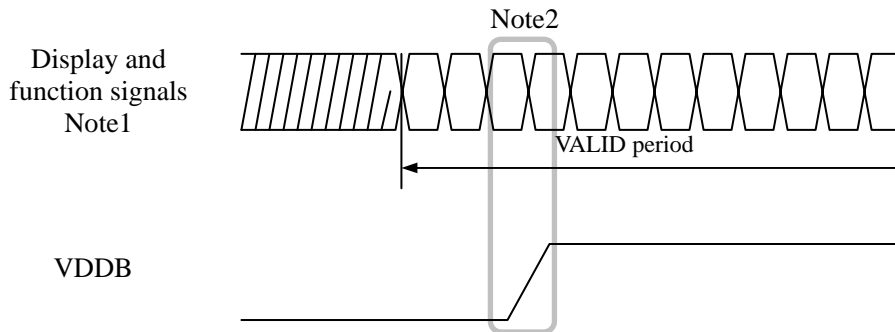

Note1: These are the display and function signals for LCD panel signal processing board.

Note2: The inverter power supply voltage (VDDB) should be inputted within the valid period of display and function signals, in order to avoid unstable data display.

PRELIMINARY

4.5 CONNECTIONS AND FUNCTIONS FOR INTERFACE PINS

4.5.1 LCD panel signal processing board

CN1 socket (LCD module side): DF9C-41P-1V (2*) (Hirose Electric Co., Ltd. (HRS))

Adaptable plug: DF9-41S-1V (2*) (Hirose Electric Co., Ltd. (HRS))

Pin No.	Symbol	Signal	Remarks
1	GND	Ground	Note1
2	CLK	Dot clock	-
3	GND	Ground	Note1
4	Hsync	Horizontal synchronous signal	-
5	Vsync	Vertical synchronous signal	
6	GND	Ground	Note1
7	GND		
8	GND		
9	R0	Red data (LSB)	Least significant bit
10	R1	Red data	-
11	R2	Red data	
12	GND	Ground	Note1
13	R3	Red data	-
14	R4	Red data	
15	R5	Red data (MSB)	Most significant bit
16	GND	Ground	Note1
17	GND		
18	GND		
19	G0	Green data (LSB)	Least significant bit
20	G1	Green data	-
21	G2	Green data	
22	GND	Ground	Note1
23	G3	Green data	-
24	G4	Green data	
25	G5	Green data (MSB)	Most significant bit
26	GND	Ground	Note1
27	GND		
28	GND		
29	B0	Blue data (LSB)	Least significant bit
30	B1	Blue data	-
31	B2	Blue data	
32	GND	Ground	Note1
33	B3	Blue data	-
34	B4	Blue data	
35	B5	Blue data (MSB)	Most significant bit
36	GND	Ground	Note1
37	DE	Selection of DE / Fixed mode	Data enable signal: DE mode High or Open: Fixed mode
38	N.C.	-	Keep this pin Open.
39	VCC	Power supply	Note1
40	VCC	Power supply	
41	DPS	Selection of scan direction	High: Reverse scan Low or Open: Normal scan Note2

Note1: All GND and VCC terminals should be used without any non-connected lines.

Note2: See "4.8 SCANNING DIRECTIONS".

PRELIMINARY

4.5.2 Backlight lamp

Attention: VBLH and VBLC must be connected correctly. If customer connects wrongly, customer will be hurt and the module will be broken.

CN2 plug (LCD module side): BHR-04VS-1 (J.S.T Mfg. Co., Ltd.)

Adaptable socket: SM03 (7-D1) B-BHS-1 (J.S.T Mfg. Co., Ltd.)

Pin No.	Symbol	Signal	Remarks
1	VBLH	High voltage (Hot)	Cable color: Pink
2	VBLH	High voltage (Hot)	Cable color: Pink
3	N. C.	-	Keep this pin Open.
4	VBLC	Low voltage (Cold)	Cable color: White

4.5.3 Positions of plugs and a socket

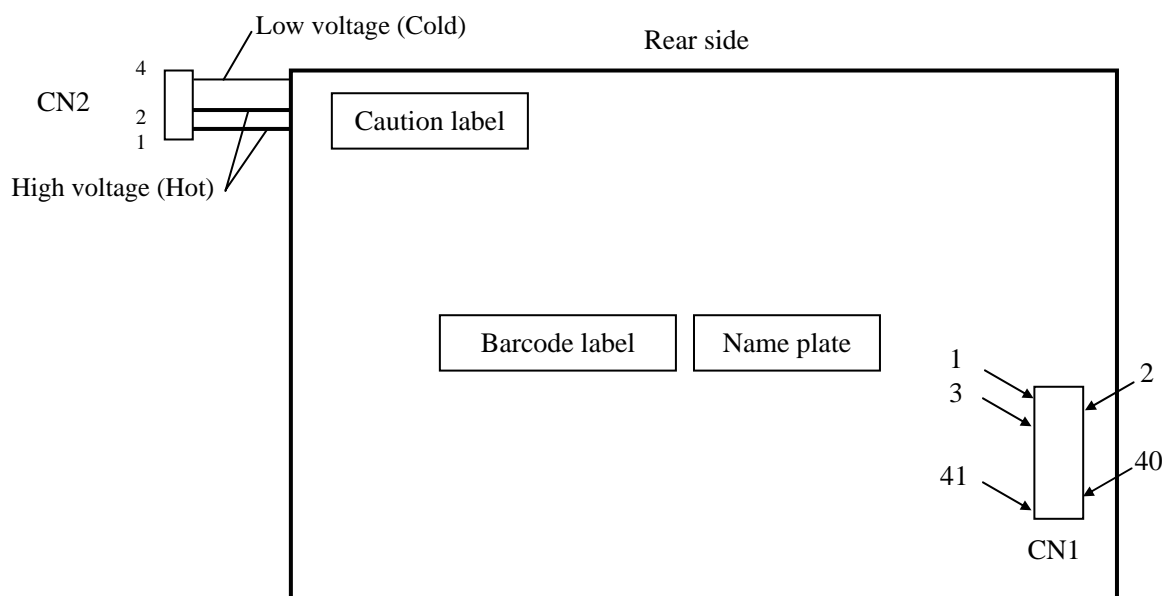

PRELIMINARY

4.6 DISPLAY COLORS AND INPUT DATA SIGNALS

This product can display in equivalent to 262,144 colors in 64 gray scales. Also the relation between display colors and input data signals is as the following table.

Display colors		Data signal (0: Low level, 1: High level)																	
		R5	R4	R3	R2	R1	R0	G5	G4	G3	G2	G1	G0	B5	B4	B3	B2	B1	B0
Basic colors	Black	0	0	0	0	0	0	0	0	0	0	0	0	0	0	0	0	0	0
	Blue	0	0	0	0	0	0	0	0	0	0	0	0	1	1	1	1	1	1
	Red	1	1	1	1	1	1	0	0	0	0	0	0	0	0	0	0	0	0
	Magenta	1	1	1	1	1	1	0	0	0	0	0	0	1	1	1	1	1	1
	Green	0	0	0	0	0	0	1	1	1	1	1	1	0	0	0	0	0	0
	Cyan	0	0	0	0	0	0	1	1	1	1	1	1	1	1	1	1	1	1
	Yellow	1	1	1	1	1	1	1	1	1	1	1	1	0	0	0	0	0	0
	White	1	1	1	1	1	1	1	1	1	1	1	1	1	1	1	1	1	1
Red gray scale	Black	0	0	0	0	0	0	0	0	0	0	0	0	0	0	0	0	0	0
		0	0	0	0	0	1	0	0	0	0	0	0	0	0	0	0	0	0
	dark	0	0	0	0	1	0	0	0	0	0	0	0	0	0	0	0	0	0
	↑				:					:						:			
	↓				:					:						:			
bright	1	1	1	1	0	1	0	0	0	0	0	0	0	0	0	0	0	0	
	1	1	1	1	1	0	0	0	0	0	0	0	0	0	0	0	0	0	
Red	1	1	1	1	1	1	0	0	0	0	0	0	0	0	0	0	0	0	
Green gray scale	Black	0	0	0	0	0	0	0	0	0	0	0	0	0	0	0	0	0	0
		0	0	0	0	0	0	0	0	0	0	1	0	0	0	0	0	0	0
	dark	0	0	0	0	0	0	0	0	0	1	0	0	0	0	0	0	0	0
	↑				:					:						:			
	↓				:					:						:			
bright	0	0	0	0	0	0	1	1	1	1	0	1	0	0	0	0	0	0	
	0	0	0	0	0	0	1	1	1	1	1	0	0	0	0	0	0	0	
Green	0	0	0	0	0	0	1	1	1	1	1	1	0	0	0	0	0	0	
Blue gray scale	Black	0	0	0	0	0	0	0	0	0	0	0	0	0	0	0	0	0	0
		0	0	0	0	0	0	0	0	0	0	0	0	0	0	0	0	0	1
	dark	0	0	0	0	0	0	0	0	0	0	0	0	0	0	0	0	1	0
	↑				:					:						:			
	↓				:					:						:			
bright	0	0	0	0	0	0	0	0	0	0	0	0	1	1	1	1	0	1	
	0	0	0	0	0	0	0	0	0	0	0	0	1	1	1	1	1	0	
Blue	0	0	0	0	0	0	0	0	0	0	0	0	1	1	1	1	1	1	

4.7 DISPLAY POSITIONS

The following table is the coordinates per pixel (See "4.8 SCANNING DIRECTIONS".).

$C(0, 0)$						
R	G	B				
$C(0, 0)$	$C(1, 0)$...	$C(X, 0)$...	$C(798, 0)$	$C(799, 0)$
$C(0, 1)$	$C(1, 1)$...	$C(X, 1)$...	$C(798, 1)$	$C(799, 1)$
.
.
.
$C(0, Y)$	$C(1, Y)$...	$C(X, Y)$...	$C(798, Y)$	$C(799, Y)$
.
.
.
$C(0, 598)$	$C(1, 589)$...	$C(X, 598)$...	$C(798, 598)$	$C(799, 598)$
$C(0, 599)$	$C(1, 599)$...	$C(X, 599)$...	$C(798, 599)$	$C(799, 599)$

4.8 SCANNING DIRECTIONS

The following figures are seen from a front view. Also the arrow shows the direction of scan.

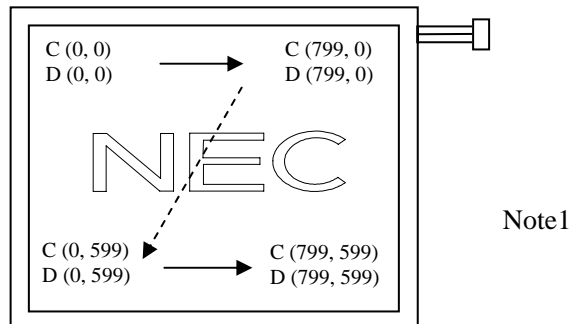

Figure 1. Normal scan (DPS: Low or Open)

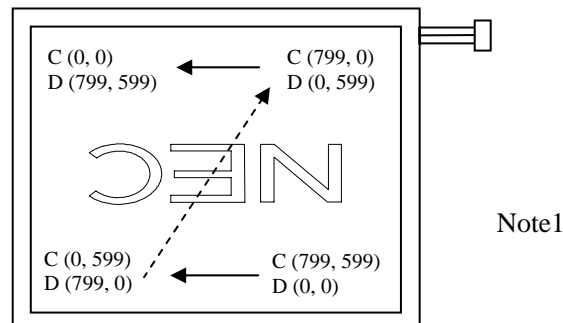

Figure 2. Reverse scan (DPS: High)

Note1: Meaning of C (X, Y) and D (X, Y)

C (X, Y): The coordinates of the display position (See "4.7 DISPLAY POSITIONS".)

D (X, Y): The data number of input signal for LCD panel signal processing board

4.9 INPUT SIGNAL TIMINGS

4.9.1 Outline of input signal timings

- Horizontal signal

Note1

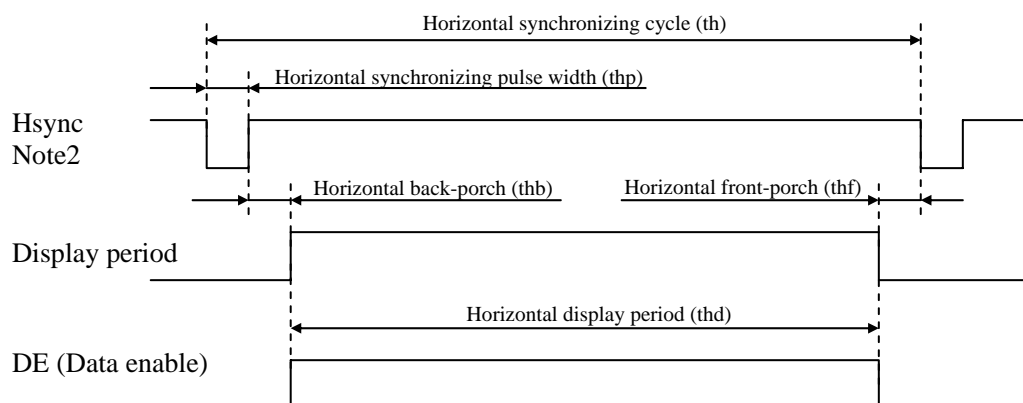

- Vertical signal

Note1

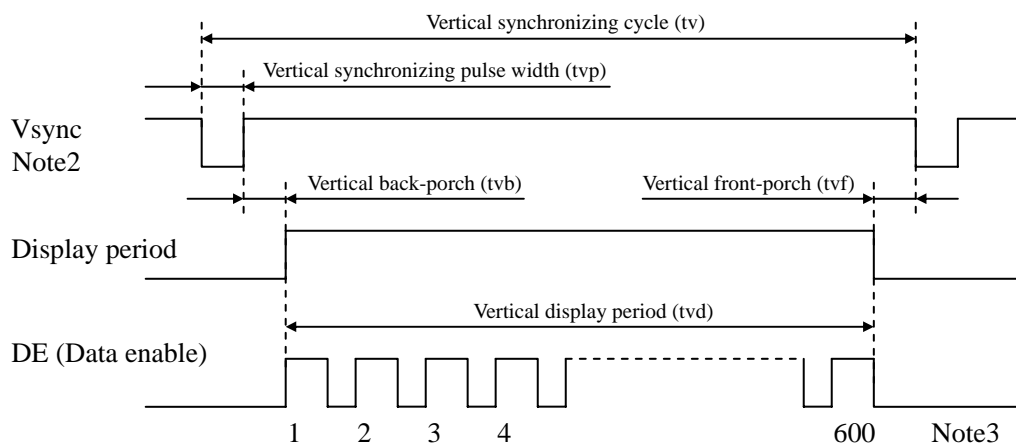

Note1: This diagram indicates virtual signal for set up to timing.

Note2: Fixed mode cannot be used while working of DE mode.

Note3: See "4.9.3 Input signal timing chart" for numeration of pulse.

PRELIMINARY

4.9.2 Timing characteristics

(a) Fixed mode

(Note1)

Parameter		Symbol	min.	typ.	max.	Unit	Remarks	
CLK	Frequency	1/tc	34.0	38.362	40.0	MHz	26.067 ns (typ.)	
	Duty	tcd	0.4	0.5	0.6	-	-	
	Rise time, Fall time	trf	-	-	10	ns		
DATA (R0-R5) (G0-G5) (B0-B5)	CLK-DATA	Setup time	tds	8	-	-	ns	-
		Hold time	tdh	10	-	-	ns	
	Rise time, Fall time	tdrf	-	-	10	ns		
Hsync	Cycle		th	24.0	26.693	30.1	μs	37.463 kHz (typ.)
				1,024			CLK	-
	Display period		thd	800			CLK	
	Front-porch		thf	24			CLK	
	Pulse width		thp	12	72	-	CLK	
	Back-porch		thb	-	128	188	CLK	
	Total of pulse width and back-porch		thp + thb	200			CLK	
	CLK- Hsync	Setup time	ths	8	-	-	ns	-
		Hold time	thh	10	-	-	ns	
Rise time, Fall time		thrf	-	-	10	ns		
Vsync	Cycle		tv	16.1	16.683	17.2	ms	59.94 Hz (typ.)
				625			H	-
	Display period		tvd	600			H	
	Front-porch		tvf	1			H	
	Pulse width		tvp	1	2	-	H	
	Back-porch		tvb	-	22	23	H	
	Total of pulse width and back-porch		tvp + tvb	24			H	
	Hsync-Vsync timing		thv	1	-	-	CLK	-
	Vsync-Hsync timing		tvh	15	-	-	ns	
Rise time, Fall time		tvrf	-	-	10	ns		

Note1: Definition of parameters is as follows.

$$tc = 1\text{CLK}, tcd = tch/tc, th = 1H$$

Note2: Keep tvp + tvb and thp + thb within the table. If it is out of specification, display position will be shifted to right/left side or up/down.

PRELIMINARY

(b) DE mode

(Note1, Note2)

Parameter		Symbol	min.	typ.	max.	Unit	Remarks	
CLK	Frequency	1/tc	34.0	38.362	40.0	MHz	26.067 ns (typ.)	
	Duty	tcd	0.4	0.5	0.6	-	-	
	Rise time, Fall time	terf	-	-	10	ns		
DATA (R0-R5) (G0-G5) (B0-B5)	CLK-DATA	Setup time	tds	8	-	-	ns	-
		Hold time	tdh	10	-	-	ns	
	Rise time, Fall time		tdrf	-	-	10	ns	
Vsync	Pulse width		tvp	1	2	-	H	-
	Vsync-DE timing	Setup time	tvds	1	-	-	CLK	
		Hold time	tvdh	1	-	-	CLK	
	Rise time, Fall time		tvrf	-	-	10	ns	
DE	Horizontal	Cycle	th	24.0	26.693	30.1	μs	37.463 kHz (typ.)
			th	829	1,024	-	CLK	-
		Display period	thd	800			CLK	-
	Vertical (One frame)	Cycle	tv	16.1	16.683	17.2	ms	59.94 Hz (typ.)
			tv	603	625	-	H	-
	CLK-DE	Display period	tvd	600			H	-
		Setup time	tdes	8	-	-	ns	-
		Hold time	tdeh	10	-	-	ns	
Rise time, Fall time		tderf	-	-	10	ns		

Note1: Definition of parameters is as follows.

tc = 1CLK, tcd = tch/tc, th = 1H

Note2: Hsync signal (Pin No.4 of CN1) is not used inside the product at DE mode, but do not keep pin open to avoid noise problem.

4.9.3 Input signal timing chart

(a) Fixed mode

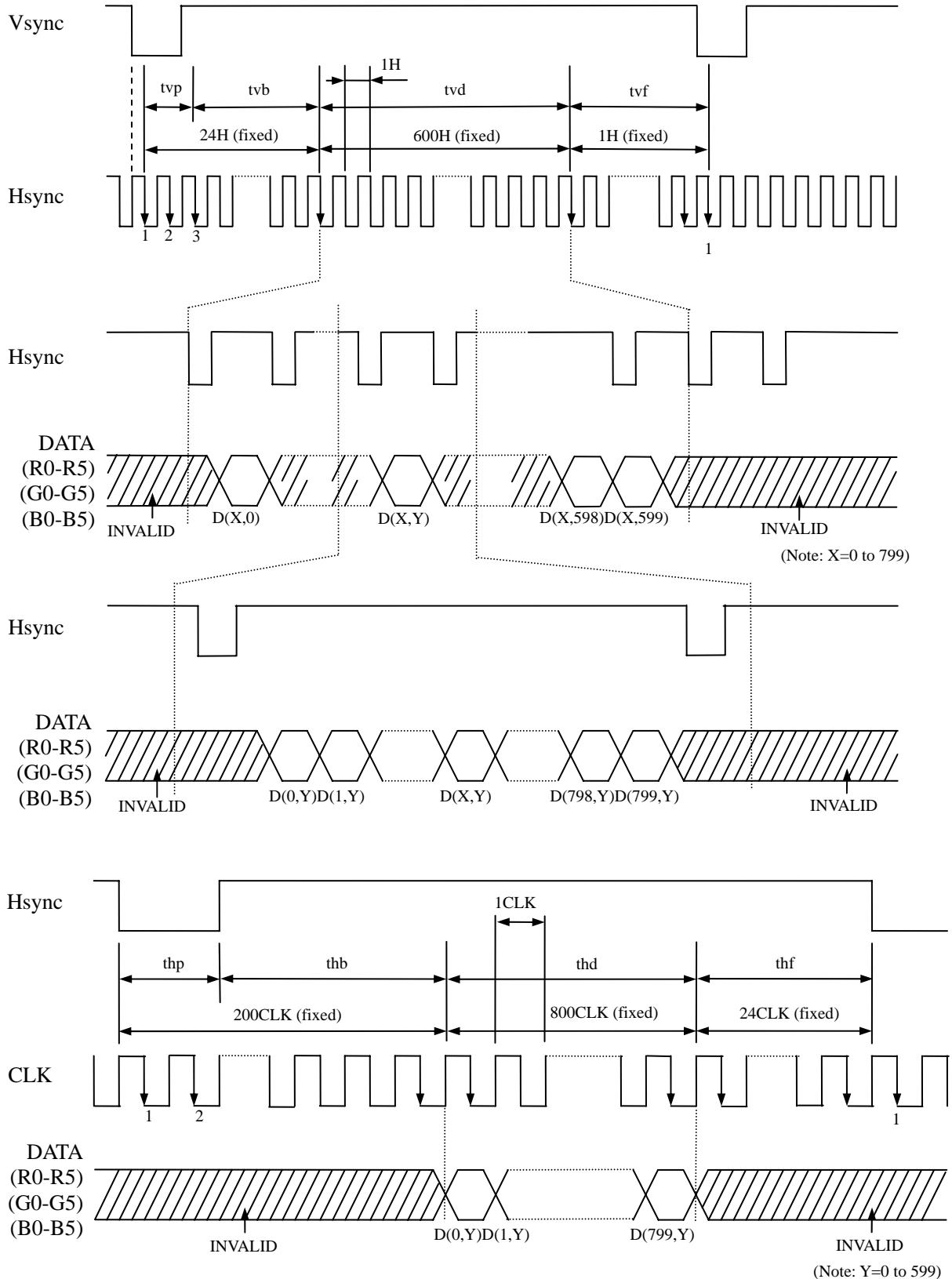

PRELIMINARY

(b) DE mode

Horizontal timing

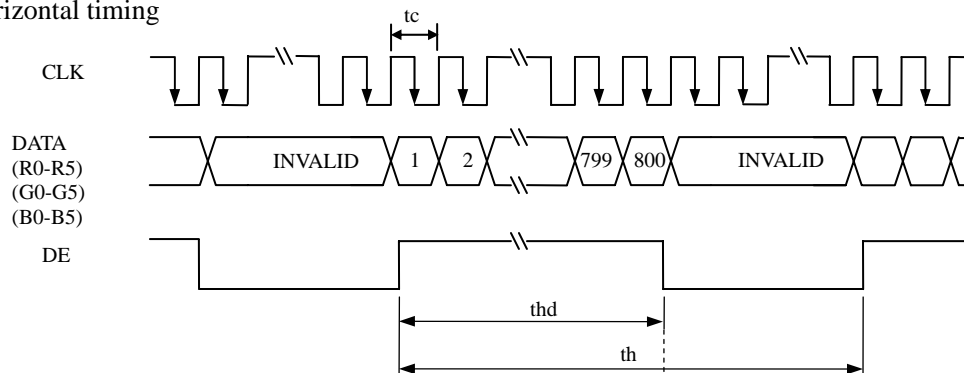

Vertical timing

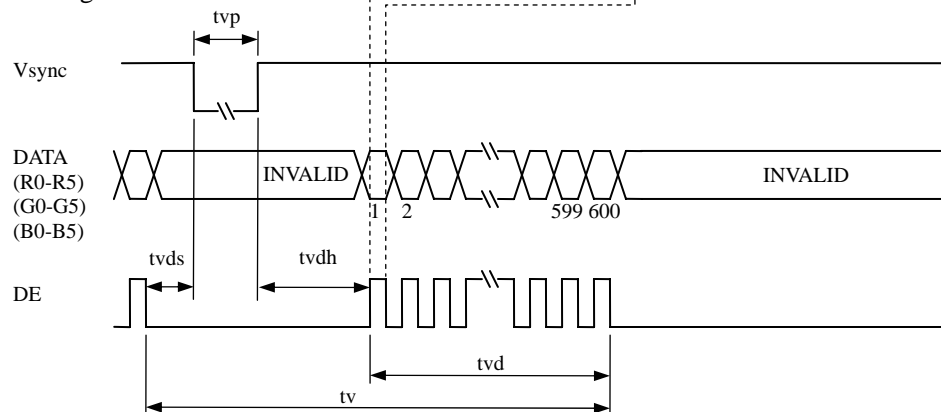

PRELIMINARY

(c) Common item of Fixed mode and DE mode

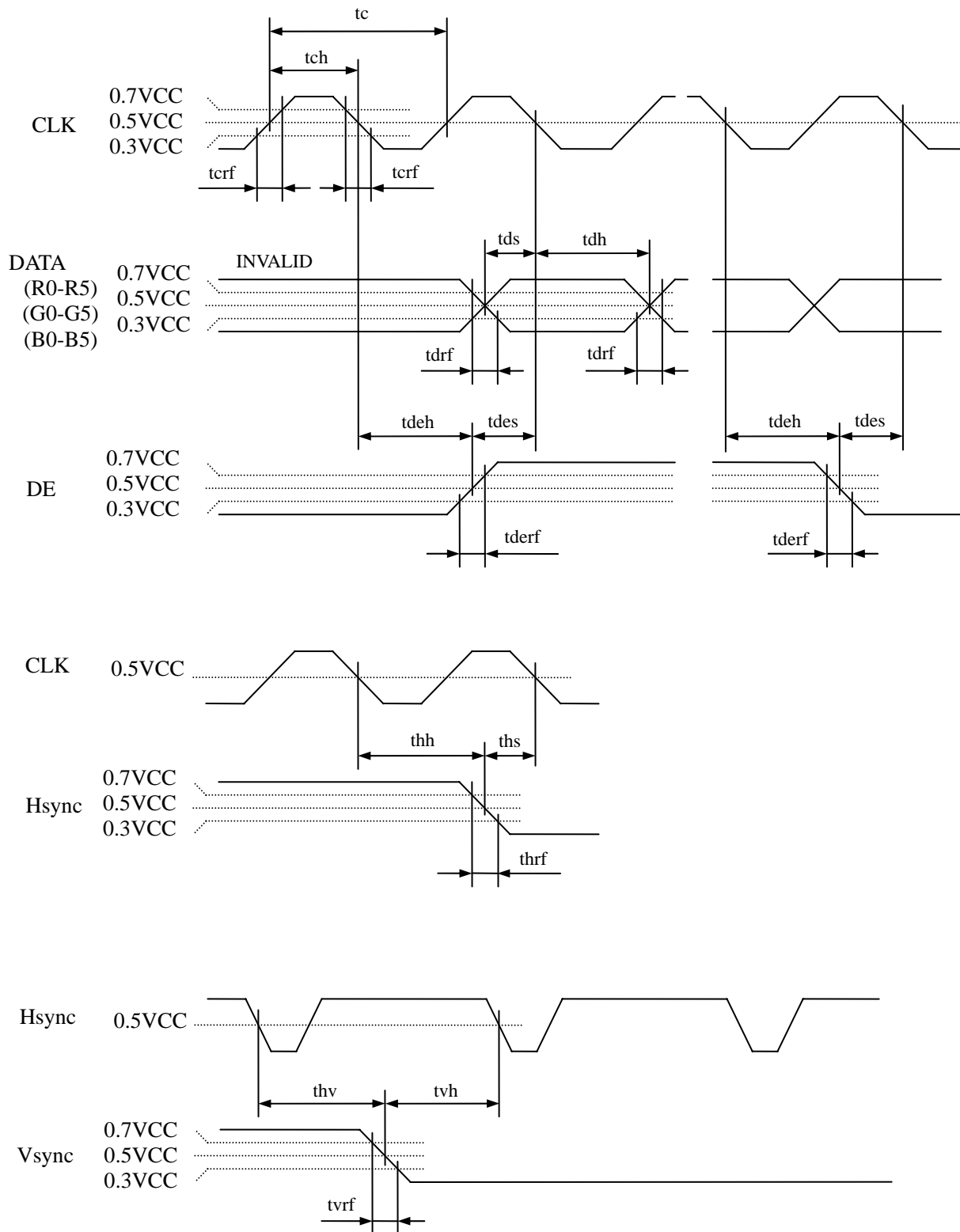

4.10 OPTICS

4.10.1 Optical characteristics transmissive mode

2

(Note1, Note2)

Parameter	Condition	Symbol	min.	typ.	max.	Unit	Remarks	
Luminance	White at center $\theta R = 0^\circ, \theta L = 0^\circ, \theta U = 0^\circ, \theta D = 0^\circ$	L	300	400	-	cd/m ²	-	
Contrast ratio	White/Black at center $\theta R = 0^\circ, \theta L = 0^\circ, \theta U = 0^\circ, \theta D = 0^\circ$	CR	300	600	-	-	Note3	
Luminance uniformity	White $\theta R = 0^\circ, \theta L = 0^\circ, \theta U = 0^\circ, \theta D = 0^\circ$	LU	-	1.25	1.40	-	Note4	
Chromaticity	White	x coordinate	Wx	0.283	0.313	0.343	-	Note5
		y coordinate	Wy	0.299	0.329	0.359	-	
	Red	x coordinate	Rx	-	0.586	-	-	
		y coordinate	Ry	-	0.345	-	-	
	Green	x coordinate	Gx	-	0.327	-	-	
		y coordinate	Gy	-	0.518	-	-	
	Blue	x coordinate	Bx	-	0.156	-	-	
		y coordinate	By	-	0.145	-	-	
Color gamut	$\theta R = 0^\circ, \theta L = 0^\circ, \theta U = 0^\circ, \theta D = 0^\circ$ at center, against NTSC color space	C	35	40	-	%		
Response time	White to Black	Ton	-	8	10	ms	Note6	
	Black to White	Toff	-	25	30	ms	Note7	
Viewing angle	Right	$\theta U = 0^\circ, \theta D = 0^\circ, CR \geq 10$	θR	60	70	-	°	Note8
	Left	$\theta U = 0^\circ, \theta D = 0^\circ, CR \geq 10$	θL	60	70	-	°	
	Up	$\theta R = 0^\circ, \theta L = 0^\circ, CR \geq 10$	θU	35	45	-	°	
	Down	$\theta R = 0^\circ, \theta L = 0^\circ, CR \geq 10$	θD	45	55	-	°	

Note1: These are initial characteristics.

Note2: Measurement conditions are as follows.

Ta=25°C, VCC=3.3V, IBL= 5.0mArms/lamp, Display mode: SVGA, Horizontal cycle = 37.463kHz, Vertical cycle = 59.94Hz, DPS= Low or Open: Normal scan

Optical characteristics are measured after 20minutes from working the product, in the dark room. Also measurement method for luminance is as follows.

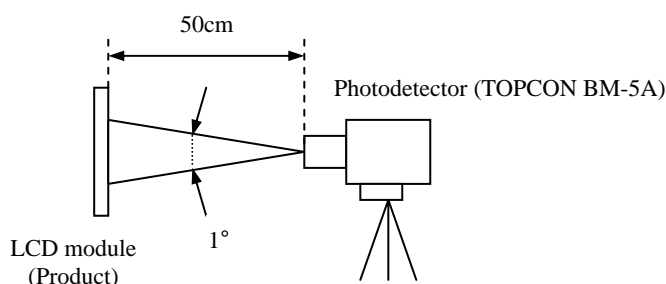

Note3: See "4.10.2 Definition of contrast ratio".

Note4: See "4.10.3 Definition of luminance uniformity".

Note5: These coordinates are found on CIE 1931 chromaticity diagram.

Note6: Product surface temperature: TopF = 28°C

Note7: See "4.10.4 Definition of response times".

Note8: See "4.10.5 Definition of viewing angles".

4.10.2 Definition of contrast ratio

The contrast ratio is calculated by using the following formula.

$$\text{Contrast ratio (CR)} = \frac{\text{Luminance of white screen}}{\text{Luminance of black screen}}$$

4.10.3 Definition of luminance uniformity

The luminance uniformity is calculated by using following formula.

$$\text{Luminance uniformity (LU)} = \frac{\text{Maximum luminance from ① to ⑤}}{\text{Minimum luminance from ① to ⑤}}$$

The luminance is measured at near the 5 points shown below.

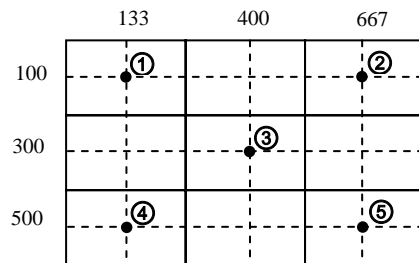

4.10.4 Definition of response times

Response time is measured, the luminance changes from "white" to "black", or "black" to "white" on the same screen point, by photo-detector. Ton is the time it takes the luminance change from 90% down to 10%. Also Toff is the time it takes the luminance change from 10% up to 90% (See the following diagram.).

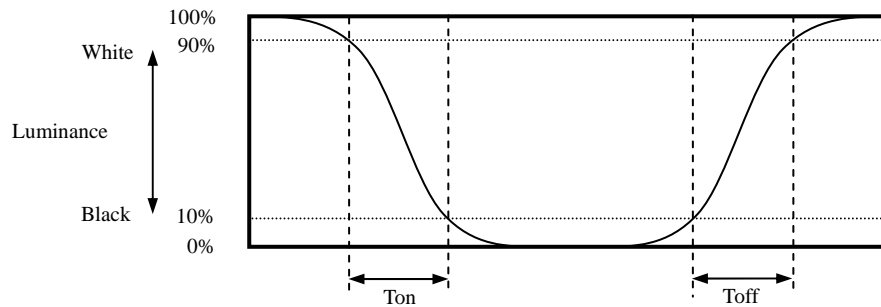

4.10.5 Definition of viewing angles

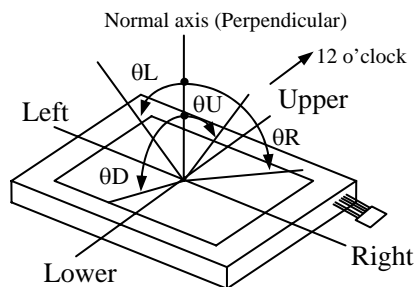

4.10.6 Optical characteristics for reflective mode (Reference)

(Note1)

Parameter	Condition	Symbol	min.	typ.	max.	Unit	Remarks
Reflectance	White at center $\theta R = 0^\circ, \theta L = 0^\circ, \theta U = 0^\circ, \theta D = 0^\circ$	R	-	2.0	-	%	Note2, 3

2

Note1: Measurement conditions are as follows.

Ta=25°C, VCC=3.3V, IBL= 5.0mAmps/lamp, Display mode: SVGA, Horizontal cycle = 37.463kHz, Vertical cycle = 59.94Hz, DPS= Low or Open: Normal scan

Optical characteristics are measured after 1 hour from working the product and the measurement light source, in the dark room.

Note2: Measurement of reflectance

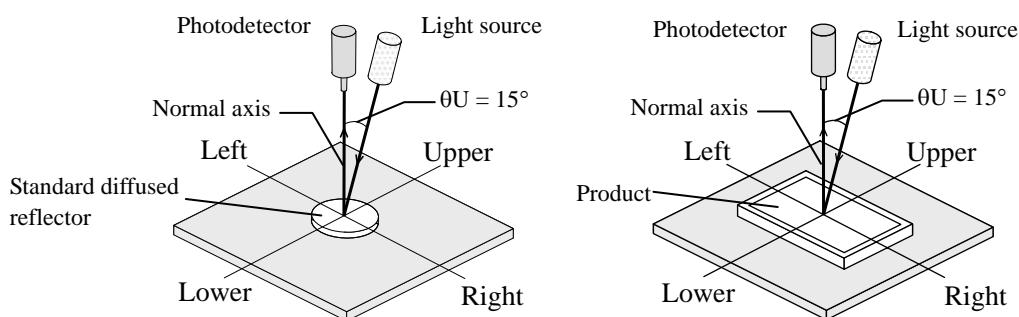

Note3: Definitions of reflectance

The reflectance is calculated by using the following formula.

$$\text{Reflectance (R)} = \frac{\text{Luminance of reflection at white screen}}{\text{Luminance of standard diffused reflector}} \times 100$$

PRELIMINARY

5. RELIABILITY TESTS

Test item	Condition	Judgement
High temperature and humidity (Operation)	① $60 \pm 2^\circ\text{C}$, RH = 90%, 240hours ② Display data is black.	No display malfunctions Note1
High temperature (Operation)	① $70 \pm 2^\circ\text{C}$, 240hours ② Display data is black.	
Heat cycle (Operation)	① $-10 \pm 3^\circ\text{C}$...1hour $70 \pm 3^\circ\text{C}$...1hour ② 50cycles, 4hours/cycle ③ Display data is black.	
Thermal shock (Non operation)	① $-20 \pm 3^\circ\text{C}$...30minutes $80 \pm 3^\circ\text{C}$...30minutes ② 100cycles, 1hour/cycle ③ Temperature transition time is within 5 minutes.	
ESD (Operation)	① 150pF, 150Ω, $\pm 10\text{kV}$ ② 9 places on a panel surface Note2 ③ 10 times each places at 1 sec interval	
Dust (Operation)	① Sample dust: No. 15 (by JIS-Z8901)) ② 15 seconds stir ③ 8 times repeat at 1 hour interval	
Vibration (Non operation)	① 5 to 100Hz, 19.6m/s^2 ② 1 minute/cycle ③ X, Y, Z direction ④ 120 times each directions	No display malfunctions No physical damages Note1
Mechanical shock (Non operation)	① 539m/s^2 , 11ms ② $\pm X$, $\pm Y$, $\pm Z$ direction ③ 5 times each directions	

Note1: Display and appearance are checked under environmental conditions equivalent to the inspection conditions of defect criteria.

Note2: See the following figure for discharge points.

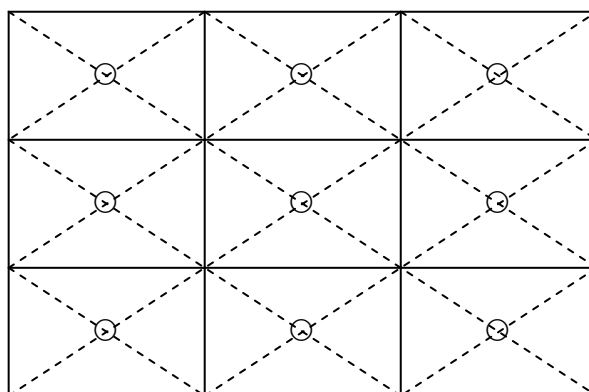

6. PRECAUTIONS

6.1 MEANING OF CAUTION SIGNS

The following caution signs have very important meaning. **Be sure to read "6.2 CAUTIONS" and "6.3 ATTENTIONS", after understanding these contents!**



This sign has the meaning that customer will be injured by himself or the product will sustain a damage, if customer has wrong operations.



This sign has the meaning that customer will get an electrical shock, if customer has wrong operations.



This sign has the meaning that customer will be injured by himself, if customer has wrong operations.

6.2 CAUTIONS



*** Do not touch the working backlight. Customer will be in danger of an electric shock.**



*** Do not touch the working backlight. Customer will be in danger of burn injury.
* Do not shock and press the LCD panel and the backlight! There is a danger of breaking, because they are made of glass. (Shock: To be not greater 539m/s² and to be not greater 11ms, Pressure: To be not greater 19.6 N)**

6.3 ATTENTIONS



6.3.1 Handling of the product

- ① Take hold of both ends without touch the circuit board cover when customer pulls out products (LCD modules) from inner packing box. If customer touches it, products may be broken down or out of adjustment, because of stress to mounting parts.
- ② Do not hook cables nor pull connection cables such as lamp cable and so on, for fear of damage.
- ③ If customer puts down the product temporarily, the product puts on flat subsoil as a display side turns down.
- ④ Take the measures of electrostatic discharge such as earth band, ionic shower and so on, when customer handles the product, because products may be damaged by electrostatic.
- ⑤ The torque for mounting screws must never exceed 0.294N·m. Higher torque values might result in distortion of the bezel.
- ⑥ The product must be installed using mounting holes without undue stress such as bends or twist (See outline drawings). And do not add undue stress to any portion (such as bezel flat area) except mounting hole portion.
Bends or twist described above and undue stress to any portion except mounting hole portion may cause display un-uniformity.
- ⑦ Do not press or rub on the sensitive display surface. If customer clean on the panel surface, NEC recommends using the cloth with ethanolic liquid such as screen cleaner for LCD.
- ⑧ Do not push-pull the interface connectors while the product is working, because wrong power sequence may break down the product.

- ⑨ Do not bend or unbend the lamp cable at the near part of the lamp holding rubber, to avoid the damage for high voltage side of the lamp. This damage may cause a lamp breaking and abnormal operation of high voltage circuit.
- ⑩ If the lamp cable is attached on the metal part of the LCD module directly, a leak high frequency current to the metal part may occur, then the brightness may decrease or the lamp may not light.
- ⑪ When not connecting FG of the LCD module to the customer's equipment ground, inverter noise may create a beat frequency that will cause video noise on the LCD screen.
- ⑫ When customer handles the product, use of an original protection sheet on the product surface (polarizer) is recommended for protection of product surface. Adhesive type protection sheet may change color or properties of the polarizer.

6.3.2 Environment

- ① Do not operate or store in high temperature, high humidity, dewdrop atmosphere or corrosive gases. Keep the product in antistatic pouch in room temperature, because of avoidance for dusts and sunlight, if customer stores the product.
- ② In order to prevent dew condensation occurring by temperature difference, the product packing box must be opened after leave under the environment of an unpacking room temperature enough. Because a situation of dew condensation occurring is changed by the environmental temperature and humidity, evaluate the leaving time sufficiently. (Recommendation leaving time: 6 hour or more with packing state)
- ③ Do not operate in high magnetic field. Circuit boards may be broken down by it.
- ④ This product is not designed as radiation hardened.

6.3.3 Characteristics

The following items are neither defects nor failures.

- ① Response time, luminance and color may be changed by ambient temperature.
- ② The LCD may be seemed luminance non-uniformity, flicker, vertical seam or small spot by display patterns.
- ③ Optical characteristics (e.g. luminance, display uniformity, etc.) gradually is going to change depending on operating time, and especially low temperature, because the LCD has cold cathode fluorescent lamps.
- ④ Do not display the fixed pattern for a long time because it may cause image sticking. Use a screen saver, if the fixed pattern is displayed on the screen.
- ⑤ The display color may be changed by viewing angle because of the use of condenser sheet in the backlight.
- ⑥ Optical characteristics may be changed by input signal timings.
- ⑦ The interference noise of input signal frequency for this product's signal processing board and luminance control frequency of customer's backlight inverter may appear on a display. Set up luminance control frequency of backlight inverter so that the interference noise does not appear.
- ⑧ Each of color of the polarizer surface at non-operation may differ because of antireflection treatment.

6.3.4 Other

- ① All GND and VCC terminals should be used without any non-connected lines.
- ② Do not disassemble a product or adjust variable resistors without permission of NEC.
- ③ See "REPLACEMENT MANUAL FOR LAMP HOLDER SET", if customer would like to replace backlight lamps.
- ④ Pay attention not to insert waste materials inside of products, if customer uses screwdrivers.
- ⑤ Pack the product with original shipping package, because of avoidance of some damages during transportation, when customer returns it to NEC for repair and so on.

PRELIMINARY

7. OUTLINE DRAWINGS

7.1 FRONT VIEW

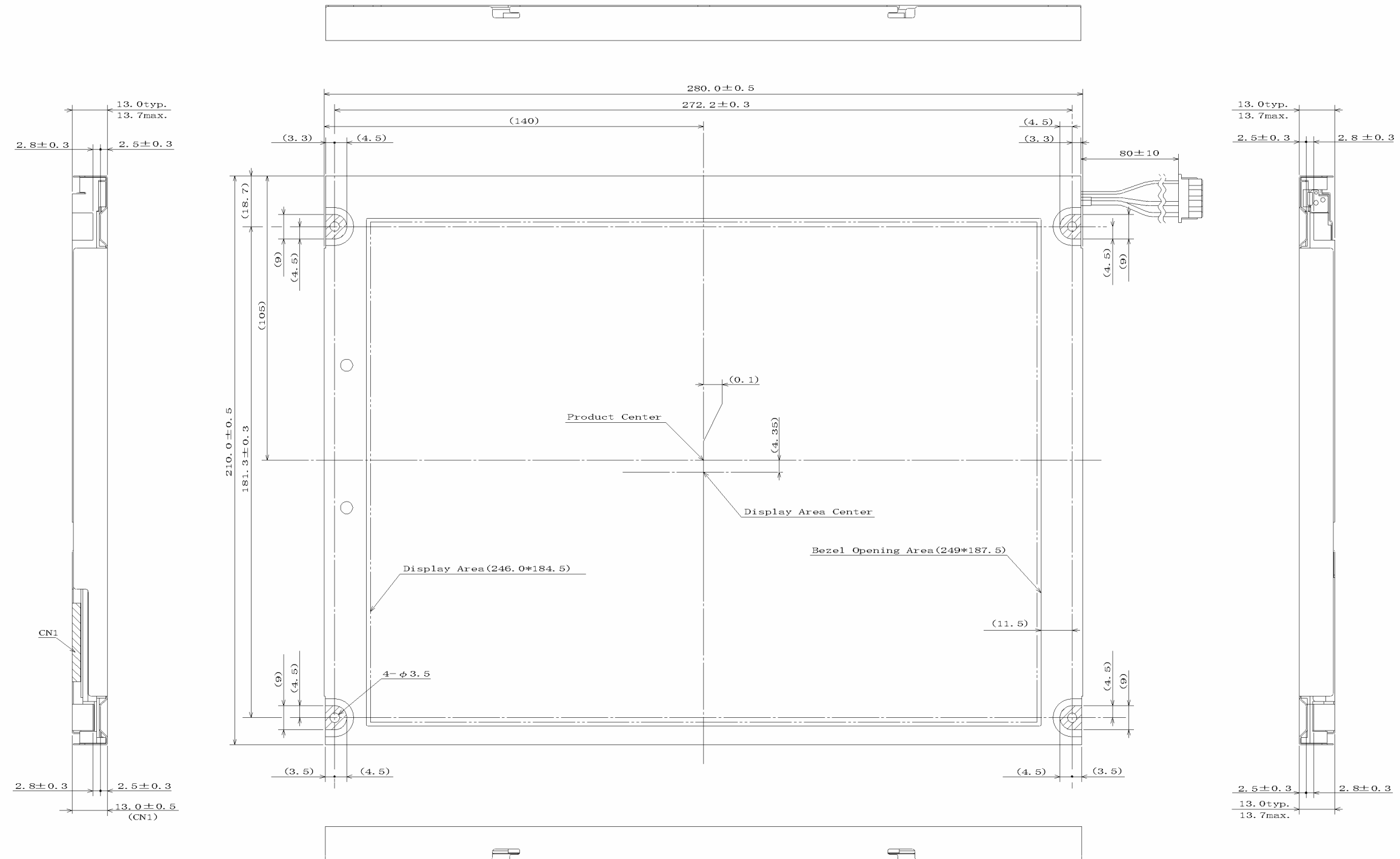

- Note1: The values in parentheses are for reference.
Note2: The torque for mounting screws must never exceed 0.294N·m.
Note3:  Mounting hole portions (4 pieces)

Unit: mm

PRELIMINARY

REVISION HISTORY

The inside of latest specifications is revised to the clerical error and the major improvement of previous edition. Only a changed part such as functions, characteristic value and so on that may affect a design of customers, are described especially below.

Edition	Document number	Prepared date	Revision contents and signature
1st edition	DOD-PD-0595	July 28, 2004	<p>Revision contents New issue</p> <p>Signature of writer</p> <p>Approved by _____ Checked by _____ Prepared by _____</p> <p style="text-align: center;">T. ITO _____ R. KAWASHIMA</p>
2nd edition	DOD-PD-0647	Sep. 14, 2004	<p>Revision contents</p> <p>P5, P7 Weight: → 740g (typ.), 770g (max.) P5, P22 Optical characteristics for transmissive mode</p> <ul style="list-style-type: none"> • Contrast: → 300(min.), 600(typ.) • Chromaticity coordinates are decided. <p>P5, P24 Optical characteristics for reflective mode</p> <ul style="list-style-type: none"> • Reflectance: → 2.0% (typ.) <p>Signature of writer</p> <p>Approved by _____ Checked by _____ Prepared by _____</p> <p style="text-align: center;"><i>T. Ito</i> _____ <i>R. Kawashima</i></p> <p style="text-align: center;">T. ITO _____ R. KAWASHIMA</p>