

TENTATIVE

All information in this technical data sheet is tentative
and subject to change without notice.

8.4"VGA

TECHNICAL SPECIFICATION

COMPANY PROPRIETARY
NOT TO BE REPRODUCED OR DISCLOSED WITHOUT
WRITTEN PERMISSION OF MITSUBISHI ELECTRIC CORPORATION
(THIS IS A RED INK STAMP)

AA084VF03

mitsubishi MITSUBISHI ELECTRIC Corp.

Date: May.26,'08

CONTENTS

| No. | Item | Page |
|-----|---|---------------|
| -- | COVER | 1 |
| -- | CONTENTS | 2 |
| 1 | APPLICATION | 3 |
| 2 | OVERVIEW | 4 |
| 3 | ABSOLUTE MAXIMUM RATINGS | 5 |
| 4 | ELECTRICAL CHARACTERISTICS | 5, 6, 7 |
| 5 | INTERFACE PIN CONNECTION | 8 |
| 6 | INTERFACE TIMING | 9, 10, 11, 12 |
| 7 | BLOCK DIAGRAM | 13 |
| 8 | MECHANICAL SPECIFICATION | 14, 15 |
| 9 | OPTICAL CHARACTERISTICS | 16, 17, 18 |
| 10 | RELIABILITY TEST CONDITION | 19 |
| 11 | OTHER FEATURE | 20 |
| 12 | HANDLING PRECAUTIONS FOR TFT-LCD MODULE | 21, 22, 23 |

1. APPLICATION

This specification applies to color TFT-LCD module, AA084VF03.

These specification papers are the proprietary product of Mitsubishi Electric Corporation ("MITSUBISHI") and include materials protected under copyright of MITSUBISHI. No part of this document may be reproduced in any form or by any means without the express written permission of MITSUBISHI.

MITSUBISHI does not assume any liability for infringement of patents, copyrights or other intellectual property rights of third parties by or arising from use of a product specified in this document. No license, express, implied or otherwise, is granted under any patents, copyrights or other intellectual property rights of MITSUBISHI or of others.

MITSUBISHI classifies the usage of the TFT-LCD module as follows. Please confirm the usage before using the product.

(1) Standard Usage

Computers, office equipment, factory automation equipment, test and measurement equipment, communications, transportation equipment(automobiles, ships, trains, etc.), provided, however, that operation is not influenced by TFT-LCD directly.

(2) Special Usage

Medical equipment, safety equipment, transportation equipment, provided, however, that TFT-LCD is necessary to its operation.

(3) Specific Usage

Cockpit Equipment, military systems, aerospace equipment, nuclear reactor control systems, life support systems and any other equipment. MITSUBISHI should make a contract that stipulate apportionment of responsibilities between MITSUBISHI and our customer.

The product specified in this document is designed for "Standard Usage" unless otherwise specified in this document. If customers intend to use the product for applications other than those specified for "Standard Usage", they should first contact MITSUBISHI sales representative for it's intended use in writing.

MITSUBISHI has been making continuous effort to improve the reliability of its products. Customers should implement sufficient reliability design of their application equipments such as redundant system design, fail-safe functions, anti-failure features.

MITSUBISHI assumes no responsibility for any damage resulting from the use of the product that does not comply with the instructions and the precautions specified in this document.

Please contact and consult a MITSUBISHI sales representative for any questions regarding this product.

2. OVERVIEW

AA084VF03 is 8.4" color TFT-LCD (Thin Film Transistor Liquid Crystal Display) module composed of LCD panel, driver ICs, control circuit, and backlight unit.

By applying 6 bit digital data, 640 × 480, 262k-color images are displayed on the 8.4" diagonal screen. Input power voltage is 3.3 V for LCD driving.

The type of data and control signals are digital and transmitted via CMOS interface per Typ. 25 MHz clock cycle.

Inverter for backlight is not included in this module. General specifications are summarized in the following table:

| ITEM | SPECIFICATION |
|--|---|
| Display Area (mm) | 170.9(H) × 128.2 (V) (8.4-inch diagonal) |
| Number of Dots | 640 × 3 (H) × 480 (V) |
| Pixel Pitch (mm) | 0.267 (H) × 0.267 (V) |
| Color Pixel Arrangement | RGB vertical stripe |
| Display Mode | Normally white TN |
| Number of Color | 262k |
| Luminance (cd/m ²) | 480 |
| Wide Viewing Angle Technology | Optical Compensation Film |
| Viewing Angle (CR ≥ 10) | -80~80°(H) -60~80°(V) |
| Surface Treatment | Anti-reflection and hard-coating 2H |
| Electrical Interface | CMOS |
| Optimum Viewing Angle (Contrast ratio) | 6 o'clock |
| Module Size (mm) | 199.5 (W) × 149.0 (H) × 11.5 (D) |
| Module Mass (g) | 350 |
| Backlight Unit | CCFL, 2-tubes, edge-light, replaceable |

Characteristic value without any note is typical value.

3. ABSOLUTE MAXIMUM RATINGS

| ITEM | SYMBOL | MIN. | MAX. | UNIT |
|--|--------------------------|------|------|-------|
| Power Supply Voltage for LCD | VCC | -0.3 | 4.0 | V |
| Logic Input Voltage | VI | -0.3 | 6.0 | V |
| Lamp Voltage | VL | 0 | 2000 | Vrms |
| Lamp Current | IL | 0 | 10.0 | mArms |
| Lamp Frequency | FL | -- | 100 | kHz |
| Operation Temperature (Panel) <small>Note 1,2)</small> | T _{op(Panel)} | -30 | 80 | °C |
| Operation Temperature (Ambient) <small>Note 2)</small> | T _{op(Ambient)} | -30 | 80 | °C |
| Storage Temperature <small>Note 2)</small> | T _{stg} | -30 | 80 | °C |

[Note]

- 1) Measured at the center of active area and at the center of panel back surface
- 2) Top, Tstg ≤ 40°C : 90%RH max. without condensation
 Top, Tstg > 40°C : Absolute humidity shall be less than the value of 90%RH at 40°C without condensation.

4. ELECTRICAL CHARACTERISTICS

(1) TFT- LCD

Ambient Temperature: Ta = 25°C

| ITEM | SYMBOL | MIN. | TYP. | MAX. | UNIT | Remarks |
|----------------------------------|--------|------|------|------|-------|-------------|
| Power Supply Voltage for LCD | VCC | 3.0 | 3.3 | 3.6 | V | *1) |
| Power Supply Current for LCD | ICC | - | 320 | 500 | mA | *2) |
| Permissible Input Ripple Voltage | VRP | - | - | 100 | mVp-p | VCC = +3.3V |
| Logic Input Voltage | High | VIH | 2.0 | - | 5.5 | V |
| | Low | VIL | 0 | - | 0.8 | V |

*1) Power and signals sequence:

$$\begin{array}{ll}
 t1 \leq 10 \text{ ms} & 200 \text{ ms} \leq t4 \\
 0 < t2 \leq 50 \text{ ms} & 200 \text{ ms} \leq t5 \\
 0 < t3 \leq 50 \text{ ms} & 0 \leq t6
 \end{array}$$

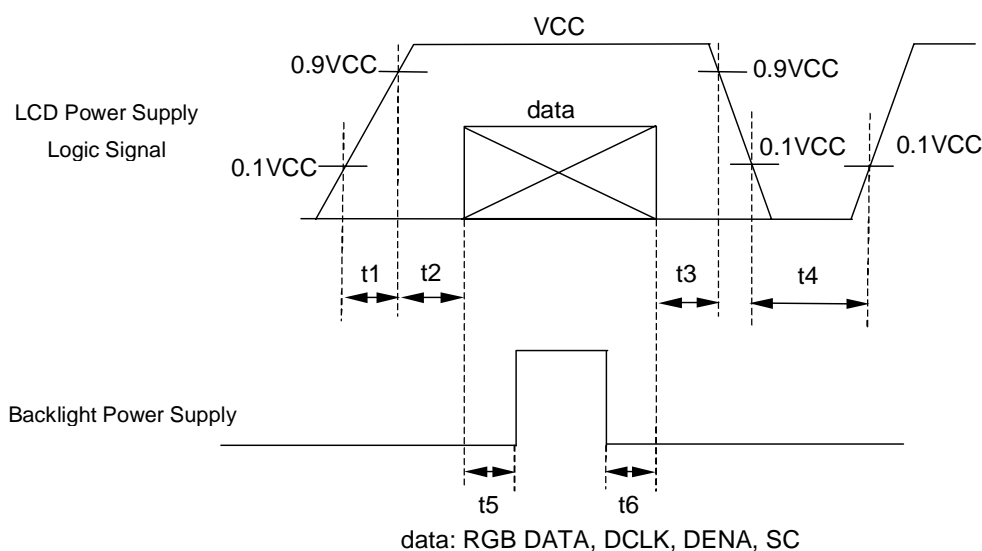

VCC-dip conditions:

- 1) When $2.4\text{ V} \leq \text{VCC} < 3.0\text{ V}$, $t_d \leq 10\text{ ms}$
- 2) When $\text{VCC} < 2.4\text{ V}$

VCC-dip conditions should also follow the power and signals sequence.

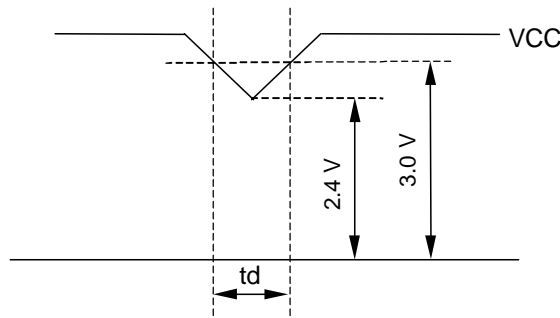

*2) $\text{VCC} = +3.3\text{ V}$, $f_H=31.5\text{ kHz}$, $f_V=60\text{ Hz}$, $f_{\text{CLK}}=25\text{ MHz}$

Display image at typical power supply current value is 64-gray-bar pattern (6 bit), 480 line mode.

*3) Fuse

| Parameter | Fuse Type Name | Supplier | Remark |
|-----------|----------------|---------------------------|--------|
| VCC | FCC16162AB | Kamaya Electric Co., Ltd. | *) |

*) The power supply capacity should be designed to be more than the fusing current.

(2) Backlight

$T_a = 25^\circ\text{C}$

| ITEM | SYMBOL | MIN. | TYP. | MAX. | UNIT | Remarks |
|-----------------------|--------|-------|------|------|-------|--|
| Lamp Voltage | VL | -- | 400 | -- | Vrms | $IL = 6.5\text{ mArms}$ |
| Lamp Current | IL | 3.0 | 6.5 | 7.5 | mArms | *1), *5) |
| Lamp Frequency | FL | 30 | -- | 70 | kHz | *2) |
| Starting Lamp Voltage | VS | 850 | -- | -- | Vrms | $T_a = 25^\circ\text{C}$ |
| | | 1190 | -- | -- | Vrms | $T_a = 0^\circ\text{C}$ |
| | | 1450 | -- | -- | Vrms | $T_a = -30^\circ\text{C}$ |
| Lamp Life Time | LT | 50000 | -- | -- | h | *3), *4) $IL = 6.5\text{ mArms}$, Continuous Operation |

*1) Lamp Current measurement method (The current meter is inserted in low voltage line.)

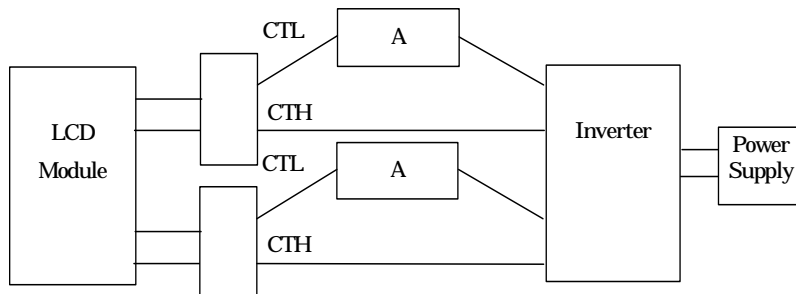

*2) Lamp frequency of inverter may produce interference with horizontal synchronous frequency, and this may cause horizontal beat on the display. Therefore, please adjust lamp frequency, and keep inverter as far from module as possible or use electronic shielding between inverter and module to avoid the interference.

- *3) Lamp life time is defined as the time either when the brightness becomes 50% of the initial value, or when the starting lamp voltage does not meet the value specified in this table.
- *4) The life time of the backlight depends on the ambient temperature. The life time will decrease under low/high temperature.

*5) Please use the inverter which has symmetrical current wave form as follows,

The degree of unbalance: less than 10%

The ratio of wave height: less than $\sqrt{2} \pm 10\%$

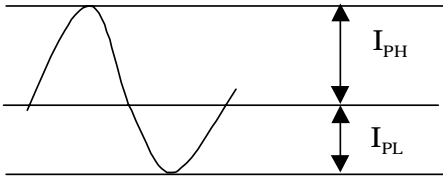

I_{PH} : High side peak

I_{PL} : Low side peak

The degree of unbalance = $|I_{PH} - I_{PL}| / I_{rms} \times 100(\%)$
 The ratio of wave height = $I_{PH}(\text{or } I_{PL}) / I_{rms}$

CURRENT WAVE FORM

5. INTERFACE PIN CONNECTION

(1) CN 1(Interface Signal)

Used connector: DF9BA-31P-1V(32) (HIROSE)

Corresponding connector: DF9B-31S-1V (HIROSE)

| Pin No. | Symbol | Function |
|---------|--------|--|
| 1 | GND | |
| 2 | DCLK | Clock signal for sampling catch data signal |
| 3 | HD | Horizontal sync signal *1) |
| 4 | VD | Vertical sync signal *1) |
| 5 | GND | |
| 6 | R0 | Red data signal(LSB) |
| 7 | R1 | Red data signal |
| 8 | R2 | Red data signal |
| 9 | R3 | Red data signal |
| 10 | R4 | Red data signal |
| 11 | R5 | Red data signal(MSB) |
| 12 | GND | |
| 13 | G0 | Green data signal(LSB) |
| 14 | G1 | Green data signal |
| 15 | G2 | Green data signal |
| 16 | G3 | Green data signal |
| 17 | G4 | Green data signal |
| 18 | G5 | Green data signal(MSB) |
| 19 | GND | |
| 20 | B0 | Blue data signal(LSB) |
| 21 | B1 | Blue data signal |
| 22 | B2 | Blue data signal |
| 23 | B3 | Blue data signal |
| 24 | B4 | Blue data signal |
| 25 | B5 | Blue data signal(MSB) |
| 26 | GND | |
| 27 | DENA | Data enable signal (to settle the viewing area) |
| 28 | VCC | 3.3 V Power Supply |
| 29 | VCC | 3.3 V Power Supply |
| 30 | NC | This pin should be open. |
| 31 | SC | Scan direction control. Low = Normal, High = Reverse |

*1) HD and VD are not being used for timing control.

*2) Metal frame is connected to signal GND.

(2) CN 2 , CN 3 (Backlight)

Backlight-side connector: BHR-02(8.0)VS-1N (JST)

Inverter-side connector: SM02(8.0)B-BHS(LF)(SN) (JST)

| Pin No. | Symbol | Function |
|---------|--------|-----------------------|
| 1 | CTH | VBLH (High Voltage) |
| 2 | CTL | VBLL (Low Voltage) |

[Note]

VBLH-VBLL = VL

6. INTERFACE TIMING

(1) Timing Specifications

| ITEM | | SYMBOL | MIN. | TYP. | MAX. | UNIT | |
|---------------------|-------------|------------------|-----------------|------|------|------|------------------|
| DCLK | Frequency | f _{CLK} | 20 | 25 | 30 | MHz | |
| | Period | t _{CLK} | 33.3 | 40 | 50 | ns | |
| | Low Width | t _{WCL} | 10 | -- | -- | ns | |
| | High Width | t _{WCH} | 10 | -- | -- | ns | |
| DATA(R,G,B) DENA | Set up time | t _{DS} | 4 | -- | -- | ns | |
| | Hold time | t _{DH} | 4 | -- | -- | ns | |
| DENA | Horizontal | Active Time | t _{HA} | 640 | 640 | 640 | t _{CLK} |
| | | Blanking Time | t _{HB} | 20 | 160 | -- | t _{CLK} |
| | | Frequency | f _H | 27 | 31.5 | 38 | kHz |
| | | Period | t _H | 26.3 | 31.7 | 37.0 | μs |
| | Vertical | Active Time | t _{VA} | 480 | 480 | 480 | t _H |
| | | Blanking Time | t _{VB} | 4 | 45 | -- | t _H |
| | | Frequency | f _V | 55 | 60 | 70 | Hz |
| | | Period | t _V | 14.3 | 16.7 | 18.2 | ms |

[Note]

- 1) DATA is latched at fall edge of DCLK in this specification.
- 2) DENA (Data Enable) should always be positive polarity as shown in the timing specification.
- 3) DCLK should appear during all invalid period.
- 4) In case of blanking time fluctuation, please satisfy following condition.

$$t_{VBn} > t_{VBn-1} - 3(t_H)$$

(2) Timing Chart

a. Pixel Timing Chart

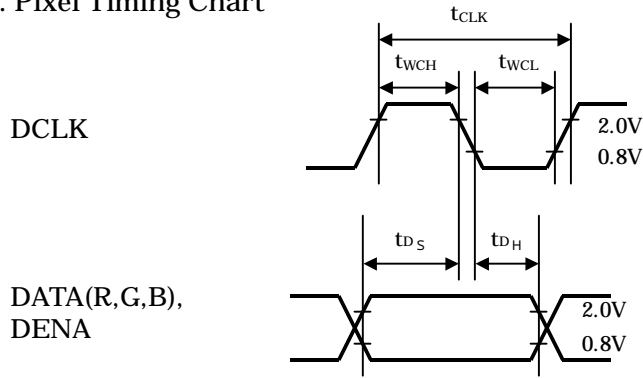

b. Horizontal Timing Chart

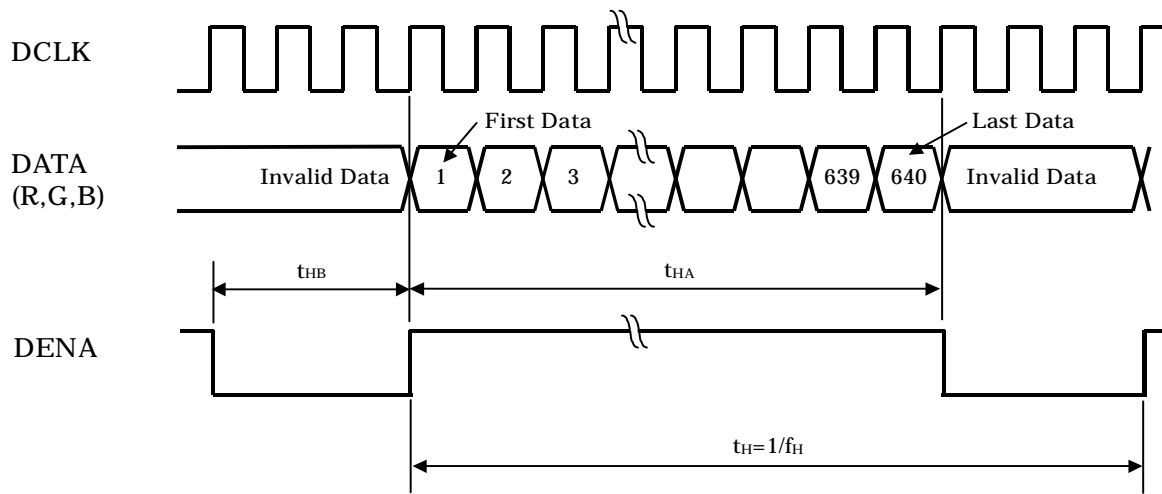

c. Vertical Timing Chart

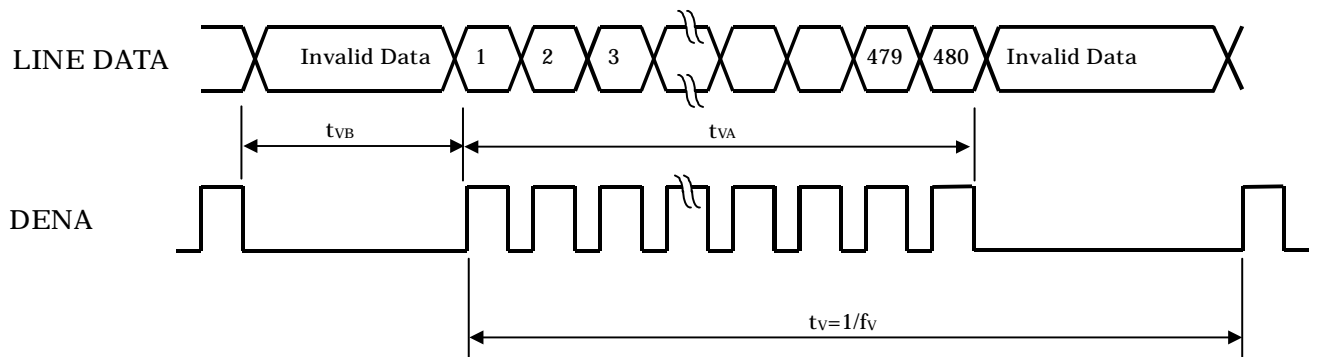

(3) Color Data Assignment

| COLOR | | INPUT DATA | | | | | | | | | | | | | | | | | |
|----------------|-----------|------------|----|----|----|----|-----|--------|----|----|----|----|-----|--------|----|----|----|----|-----|
| | | R DATA | | | | | | G DATA | | | | | | B DATA | | | | | |
| | | R5 | R4 | R3 | R2 | R1 | R0 | G5 | G4 | G3 | G2 | G1 | G0 | B5 | B4 | B3 | B2 | B1 | B0 |
| | | MSB | | | | | LSB | MSB | | | | | LSB | MSB | | | | | LSB |
| BASIC COLOR | BLACK | 0 | 0 | 0 | 0 | 0 | 0 | 0 | 0 | 0 | 0 | 0 | 0 | 0 | 0 | 0 | 0 | 0 | 0 |
| | RED(63) | 1 | 1 | 1 | 1 | 1 | 1 | 0 | 0 | 0 | 0 | 0 | 0 | 0 | 0 | 0 | 0 | 0 | 0 |
| | GREEN(63) | 0 | 0 | 0 | 0 | 0 | 0 | 1 | 1 | 1 | 1 | 1 | 1 | 0 | 0 | 0 | 0 | 0 | 0 |
| | BLUE(63) | 0 | 0 | 0 | 0 | 0 | 0 | 0 | 0 | 0 | 0 | 0 | 0 | 1 | 1 | 1 | 1 | 1 | 1 |
| | CYAN | 0 | 0 | 0 | 0 | 0 | 0 | 1 | 1 | 1 | 1 | 1 | 1 | 1 | 1 | 1 | 1 | 1 | 1 |
| | MAGENTA | 1 | 1 | 1 | 1 | 1 | 1 | 0 | 0 | 0 | 0 | 0 | 0 | 1 | 1 | 1 | 1 | 1 | 1 |
| | YELLOW | 1 | 1 | 1 | 1 | 1 | 1 | 1 | 1 | 1 | 1 | 1 | 1 | 0 | 0 | 0 | 0 | 0 | 0 |
| | WHITE | 1 | 1 | 1 | 1 | 1 | 1 | 1 | 1 | 1 | 1 | 1 | 1 | 1 | 1 | 1 | 1 | 1 | 1 |
| RED | RED(1) | 0 | 0 | 0 | 0 | 0 | 1 | 0 | 0 | 0 | 0 | 0 | 0 | 0 | 0 | 0 | 0 | 0 | 0 |
| | RED(2) | 0 | 0 | 0 | 0 | 1 | 0 | 0 | 0 | 0 | 0 | 0 | 0 | 0 | 0 | 0 | 0 | 0 | 0 |
| | | | | | | | | | | | | | | | | | | | |
| | | | | | | | | | | | | | | | | | | | |
| | RED(62) | 1 | 1 | 1 | 1 | 1 | 0 | 0 | 0 | 0 | 0 | 0 | 0 | 0 | 0 | 0 | 0 | 0 | 0 |
| | RED(63) | 1 | 1 | 1 | 1 | 1 | 1 | 0 | 0 | 0 | 0 | 0 | 0 | 0 | 0 | 0 | 0 | 0 | 0 |
| GREEN | GREEN(1) | 0 | 0 | 0 | 0 | 0 | 0 | 0 | 0 | 0 | 0 | 0 | 1 | 0 | 0 | 0 | 0 | 0 | 0 |
| | GREEN(2) | 0 | 0 | 0 | 0 | 0 | 0 | 0 | 0 | 0 | 0 | 1 | 0 | 0 | 0 | 0 | 0 | 0 | 0 |
| | | | | | | | | | | | | | | | | | | | |
| | GREEN(62) | 0 | 0 | 0 | 0 | 0 | 0 | 1 | 1 | 1 | 1 | 1 | 0 | 0 | 0 | 0 | 0 | 0 | 0 |
| | GREEN(63) | 0 | 0 | 0 | 0 | 0 | 0 | 1 | 1 | 1 | 1 | 1 | 1 | 0 | 0 | 0 | 0 | 0 | 0 |
| BLUE | BLUE(1) | 0 | 0 | 0 | 0 | 0 | 0 | 0 | 0 | 0 | 0 | 0 | 0 | 0 | 0 | 0 | 0 | 0 | 1 |
| | BLUE(2) | 0 | 0 | 0 | 0 | 0 | 0 | 0 | 0 | 0 | 0 | 0 | 0 | 0 | 0 | 0 | 0 | 1 | 0 |
| | | | | | | | | | | | | | | | | | | | |
| | | | | | | | | | | | | | | | | | | | |
| | BLUE(62) | 0 | 0 | 0 | 0 | 0 | 0 | 0 | 0 | 0 | 0 | 0 | 0 | 1 | 1 | 1 | 1 | 1 | 0 |
| | BLUE(63) | 0 | 0 | 0 | 0 | 0 | 0 | 0 | 0 | 0 | 0 | 0 | 0 | 1 | 1 | 1 | 1 | 1 | 1 |

[Note]

- 1) Definition of gray scale
 Color (n) ---n indicates gray scale level.
 Higher n means brighter level.
- 2) Data
 1:High, 0: Low

(4) Display Position and Scan Direction

D(X,Y) shows the data number of input signal for LCD panel signal processing PCB.

SC: Low

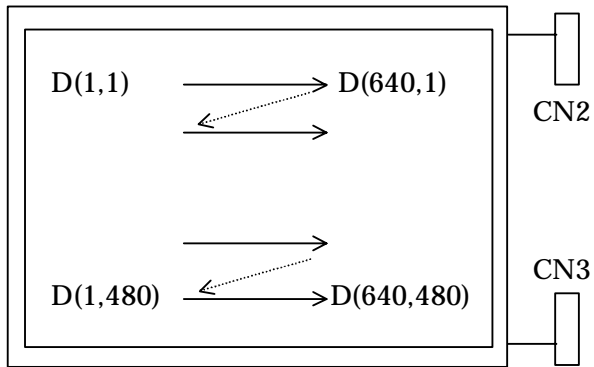

SC: High

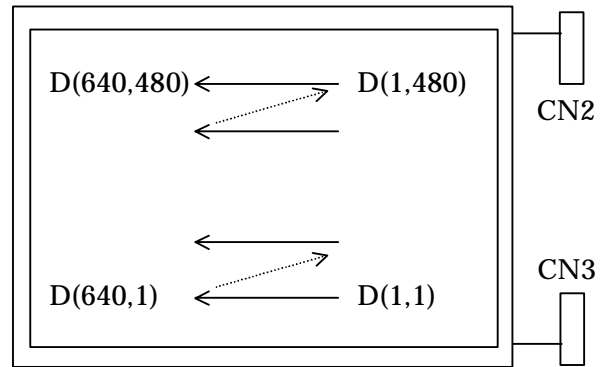

7. BLOCK DIAGRAM

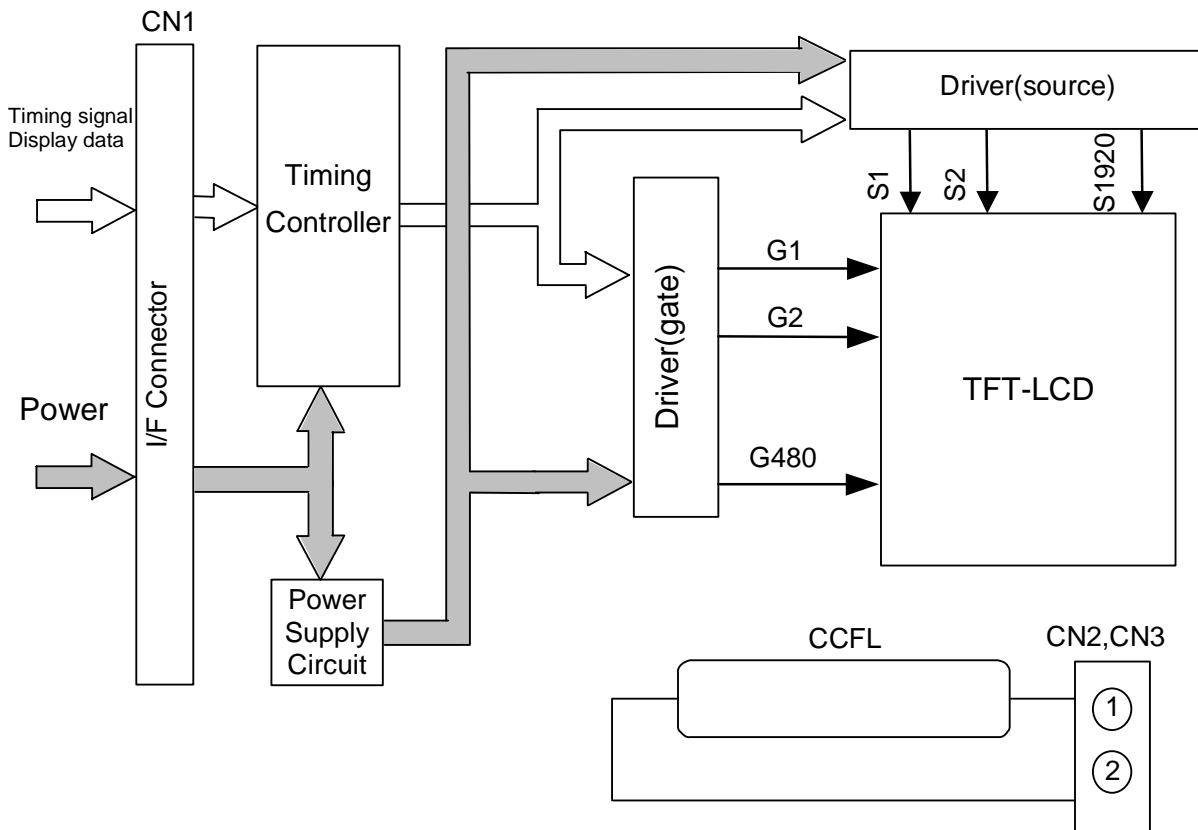

8. MECHANICAL SPECIFICATIONS

(1) Front Side

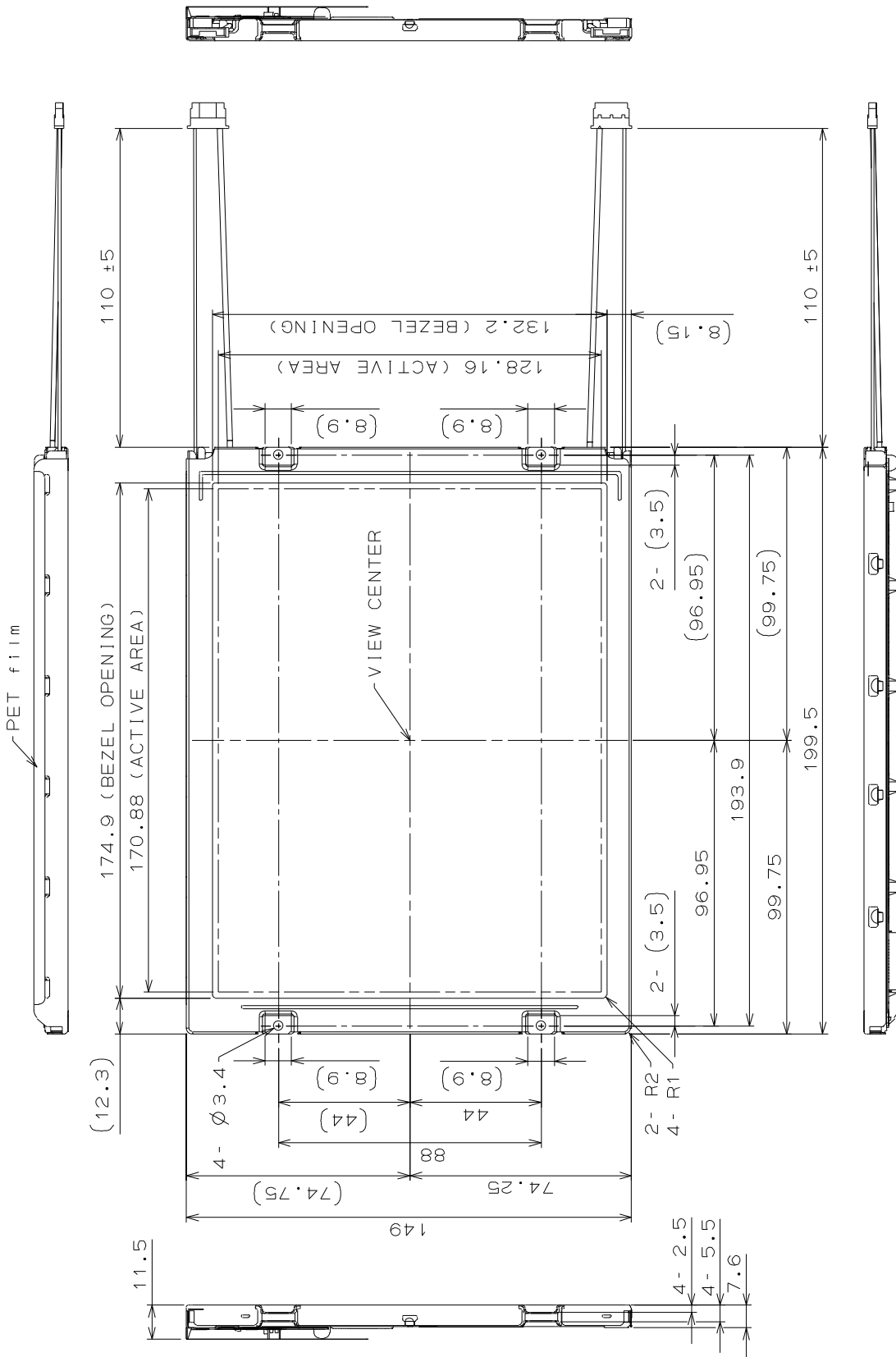

AA084VF03

- 1) Tolerance is ±0.5mm unless noted.
- 2) Thickness of PET film is not included.
- 3) Third angle projection

Unit: mm

(2) Rear Side

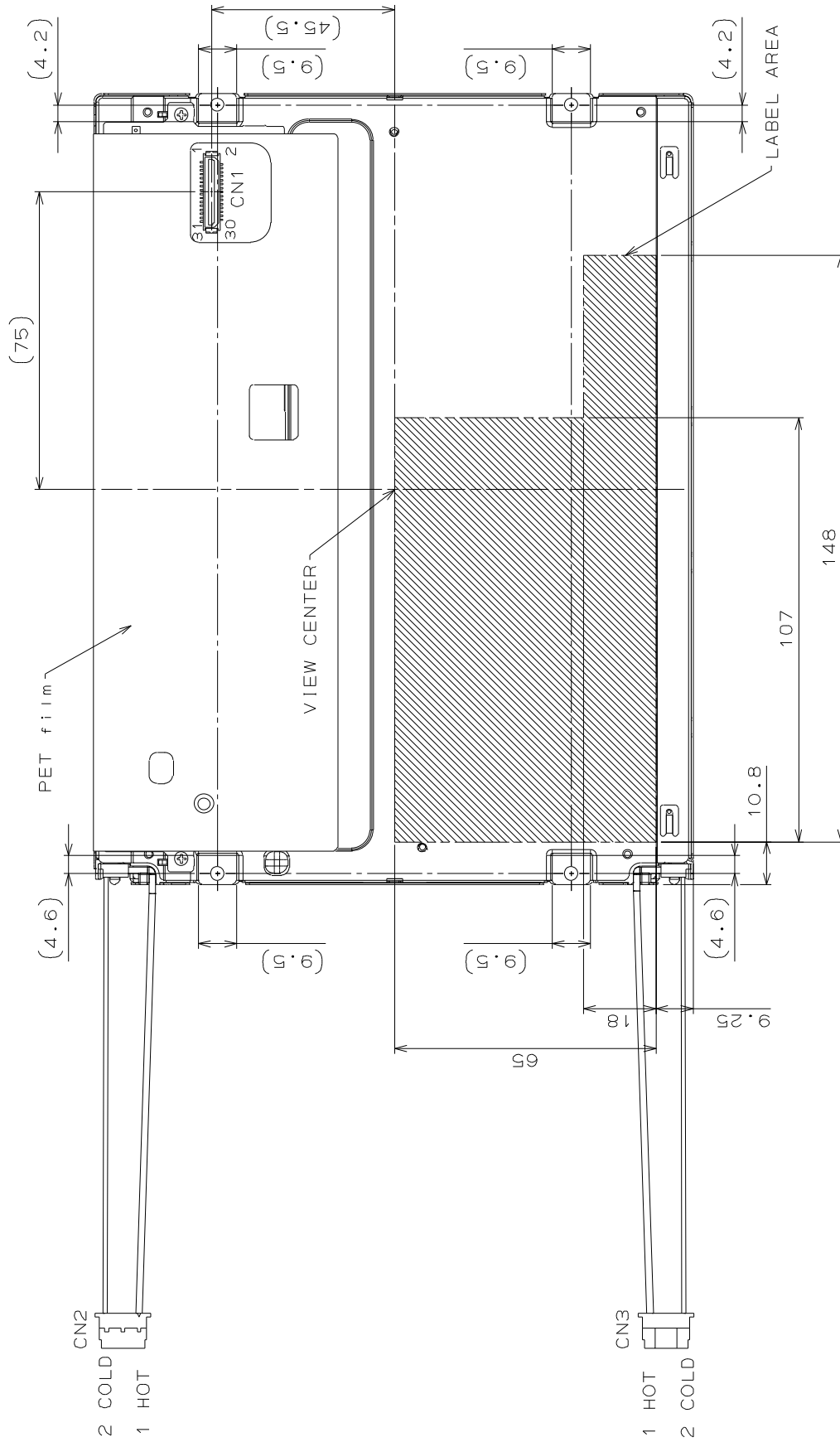

AA084VF03

- 1) Tolerance is $\pm 0.5\text{mm}$ unless noted.
- 2) Thickness of PET film is not included.
- 3) Third angle projection

CN1: DF9BA-31P-1V(32)(HIROSE)
 CN2,3: BHR-02(8.0)VS-1N(JST)

Unit: mm

9. OPTICAL CHARACTERISTICS

Ta=25°C, VCC=3.3V, Input Signals: Typ. Values shown in Section 6

| ITEM | SYMBOL | CONDITION | MIN. | TYP. | MAX. | UNIT | Remarks | |
|----------------------|-------------|--------------------------------------|--------------------------------------|--------|--------|-------------------|-----------|--------|
| Contrast Ratio | CR | $\theta_V=0^\circ, \theta_H=0^\circ$ | 390 | 600 | -- | -- | *1)*2)*5) | |
| Luminance | Lw | $\theta_V=0^\circ, \theta_H=0^\circ$ | 380 | 480 | -- | cd/m ² | *1)*5) | |
| Luminance Uniformity | ΔLw | $\theta_V=0^\circ, \theta_H=0^\circ$ | -- | -- | 30 | % | *1)*3)*5) | |
| Response Time | tr | $\theta_V=0^\circ, \theta_H=0^\circ$ | -- | 4 | -- | ms | *1)*4)*5) | |
| | tf | $\theta_V=0^\circ, \theta_H=0^\circ$ | -- | 12 | -- | ms | *1)*4)*5) | |
| Viewing Angle | Horizontal | θ_H | CR \geq 10 | -70~70 | -80~80 | -- | ° | *1)*5) |
| | Vertical | θ_V | | -50~70 | -60~80 | -- | ° | *1)*5) |
| Image Sticking | tis | 2 h | -- | -- | 2 | s | *6) | |
| Color Coordinates | Red | Rx | $\theta_V=0^\circ, \theta_H=0^\circ$ | 0.530 | 0.560 | 0.590 | -- | *1)*5) |
| | | Ry | | 0.291 | 0.321 | 0.351 | | |
| | Green | Gx | | 0.283 | 0.313 | 0.343 | | |
| | | Gy | | 0.499 | 0.529 | 0.559 | | |
| | Blue | Bx | | 0.125 | 0.155 | 0.185 | | |
| | | By | | 0.113 | 0.143 | 0.173 | | |
| | White | Wx | | 0.283 | 0.313 | 0.343 | | |
| | | Wy | | 0.299 | 0.329 | 0.359 | | |

[Note]

These items are measured using CS1000(MINOLTA) for color coordinates, EZContrast(ELDIM) for viewing angle, and CS1000 or BM-5A(TOPCON) for others under the dark room condition (no ambient light) after more than 30 minutes from turning on the lamp unless noted.

Condition: IL=6.5 mArms, FL=55 kHz

Measurement method for luminance and color coordinates is as follows.

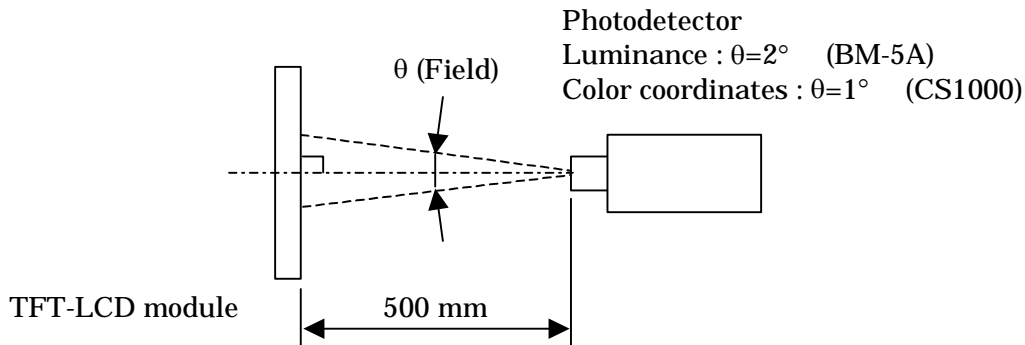

The luminance is measured according to FLAT PANEL DISPLAY MEASUREMENTS STANDARD (VESA Standard).

*1) Measurement Point

Contrast Ratio, Luminance, Response Time, Viewing Angle, Color Coordinates: Display Center
 Luminance Uniformity: point 1~5 shown in a figure below

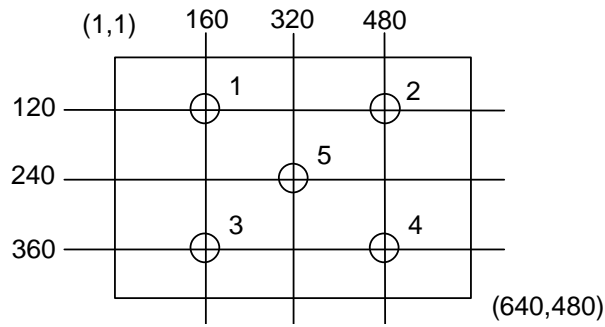

*2) Definition of Contrast Ratio

$CR = \text{Luminance with all white pixels} / \text{Luminance with all black pixels}$

*3) Definition of Luminance Uniformity

$\Delta Lw = [Lw(\text{MAX}) / Lw(\text{MIN}) - 1] \times 100$

*4) Definition of Response Time

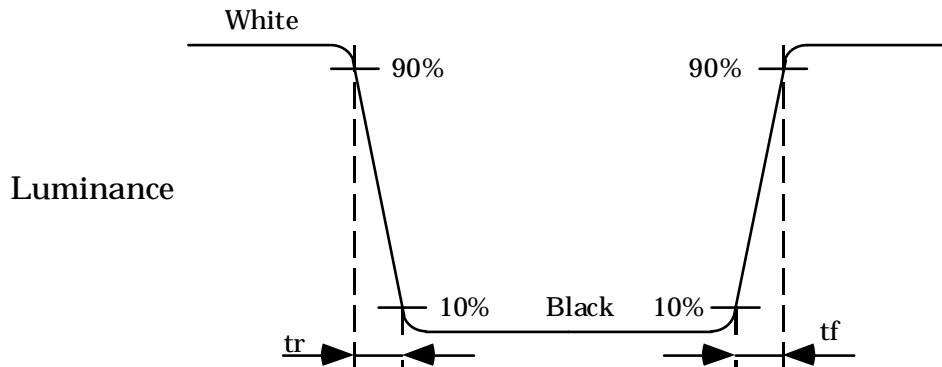

*5) Definition of Viewing Angle (θ_V , θ_H)

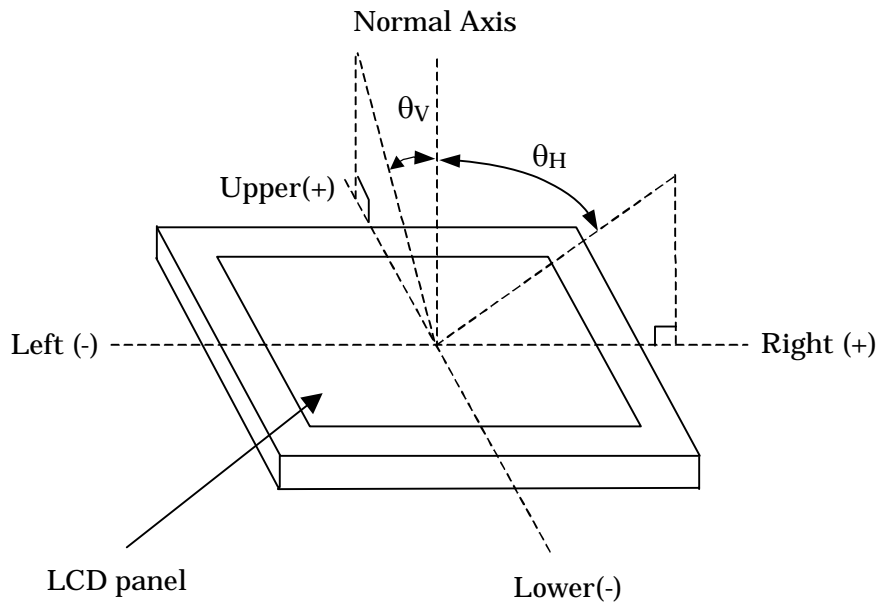

*6) Image Sticking

Continuously display the test pattern shown in the figure below for two-hours. Then display a completely white screen. The previous image shall not persist more than two seconds at 25°C.

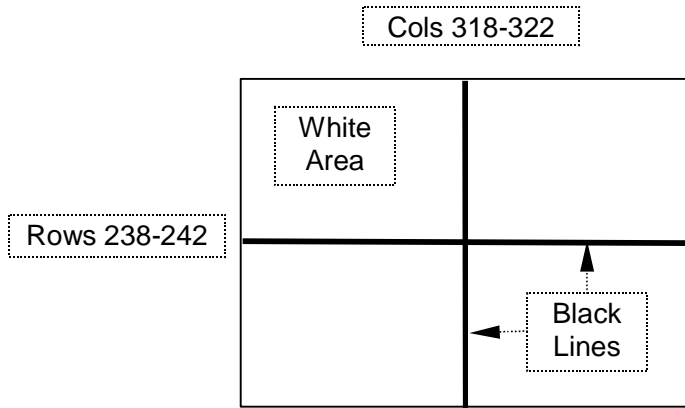

TEST PATTERN FOR IMAGE STICKING TEST

10. RELIABILITY TEST CONDITION

(1) Temperature and Humidity

| TEST ITEM | CONDITIONS |
|---|--|
| HIGH TEMPERATURE HIGH HUMIDITY OPERATION | 40°C, 90%RH, 240 h (No condensation) |
| HIGH TEMPERATURE OPERATION | 80°C, 240 h |
| LOW TEMPERATURE OPERATION | -30°C, 240 h |
| HIGH TEMPERATURE STORAGE | 80°C, 240 h |
| LOW TEMPERATURE STORAGE | -30°C, 240 h |
| THERMAL SHOCK (NON-OPERATION) | BETWEEN -30°C (1h) and 80°C(1h), 100 CYCLES |

(2) Shock & Vibration

| ITEM | CONDITIONS |
|------------------------------|--|
| SHOCK (NON-OPERATION) | Shock level: 1470 m/s ² (150G) Waveform: half sinusoidal wave, 2 ms Number of shocks: one shock input in each direction of three mutually perpendicular axis for a total of six shock inputs |
| VIBRATION (NON-OPERATION) | Vibration level: 9.8 m/s ² (1.0G)(Zero to Peak) Waveform: sinusoidal Frequency range: 5 to 500 Hz Frequency sweep rate: 0.5 octave /min Duration: one sweep from 5 to 500 Hz in each of three mutually perpendicular axis(each x,y,z axis: 1 hour, total 3 hours) |

(3) Judgment standard

The judgment of the above tests should be made as follow:

Pass: Normal display image, no damage of the display function. (ex. no line defect)

Partial transformation of the module parts should be ignored.

Fail: No display image, damage of the display function. (ex. line defect)

11. OTHER FEATURE

This LCD module complies with RoHS *) directive.

*) RoHS: Restriction of the use of certain hazardous substances in electrical and electronic equipment

12. HANDLING PRECAUTIONS FOR TFT-LCD MODULE

Please pay attention to the followings in handling TFT-LCD products;

(1) ASSEMBLY PRECAUTION

- a. Please mount the LCD module by using mounting hole with a screw clamping torque (recommended value: 0.3 Nm). Please do not bend or wrench the LCD module in assembling. Please do not drop, bend or twist the LCD module in handling.
- b. Please design display housing in accordance with the following guide lines.
 - (a) Housing case must be designed carefully so as not to put stresses on LCD and not to wrench module.
 - (b) Keep sufficient clearance between LCD module back surface and housing when the LCD module is mounted. Approximately 1.0mm of the clearance in the design is recommended taking into account the tolerance of LCD module thickness and mounting structure height on the housing.
 - (c) When some parts, such as, FPC cable and ferrite plate, are installed underneath the LCD module, still sufficient clearance is required, such as 0.5mm. This clearance is, especially, to be reconsidered when the additional parts are implemented for EMI countermeasure.
 - (d) Design the inverter location and connector position carefully so as not to give stress to lamp cable, or not to interfere the LCD module by the lamp cable.
 - (e) Keep sufficient clearance between LCD module and the others parts, such as inverter and speaker so as not to interfere the LCD module. Approximately 1.0mm of the clearance in the design is recommended.
 - (f) To avoid local elevation/decrease of temperature, considering location of heating element, heat release, thermal design should be done.
- c. Please do not push or scratch LCD panel surface with anything hard. And do not soil LCD panel surface by touching with bare hands. (Polarizer film, surface of LCD panel is easy to be flawed.)
- d. Please wipe off LCD panel surface with absorbent cotton or soft cloth in case of it being soiled.
- e. Please wipe off drops of adhesives like saliva and water on LCD panel surface immediately. They might damage to cause panel surface variation and color change.
- f. Please do not take a LCD module to pieces and reconstruct it. Resolving and reconstructing modules may cause them not to work well.
- g. Please do not touch metal frames with bare hands and soiled gloves. A color change of the metal frames can happen during a long preservation of soiled LCD modules.
- h. Please handle metal frame carefully because edge of metal frame is very sharp.
- i. Please pay attention to handling lead wire of backlight so that it is not tugged in connecting with inverter.

- j. Please connect the metal frame of LCD module to GND in order to minimize the effect of external noise and EMI.
- k. Be sure to connect the cables and the connectors correctly.

(2) OPERATING PRECAUTIONS

- a. Please be sure to turn off the power supply before connecting and disconnecting signal input cable.
- b. Please do not change variable resistance settings in LCD module. They are adjusted to the most suitable value. If they are changed, it might happen LCD does not satisfy the characteristics specification.
- c. LCD backlight takes longer time to become stable of radiation characteristics in low temperature than in room temperature.
- d. The interface signal speed is very high. Please pay attention to transmission line design and other high speed signal precautions to satisfy signal specification.
- e. A condensation might happen on the surface and inside of LCD module in case of sudden change of ambient temperature. Please take care so as not to cause any damage mentioned on (1)-e.
- f. Please pay attention not to display the same pattern for very long time. Image might stick on LCD. Even if image sticking happens, it may disappear as the operation time proceeds.
- g. Please obey the same safe instructions as ones being prepared for ordinary electronic products.

(3) PRECAUTIONS WITH ELECTROSTATICS

- a. This LCD module use CMOS-IC on circuit board and TFT-LCD panel, and so it is easy to be affected by electrostatics. Please be careful with electrostatics by the way of your body connecting to the ground and so on.
- b. Please remove protection film very slowly from the surface of LCD module to prevent from electrostatics occurrence.

(4) STORAGE PRECAUTIONS

Please keep LCD in the environment of room temperature and normal humidity as far as possible when you store, and keep turns of LCD putting into storage and outgoing in time not to keep storage too long time.

(5) SAFETY PRECAUTIONS

- a. When you waste damaged or unnecessary LCDs, it is recommended to crush LCDs into pieces and wash them off with solvents such as acetone and ethanol, which should later be burned.
- b. If any liquid leaks out of a damaged glass cell and comes in contact with the hands, wash off thoroughly with soap and water.

- c. Be sure to turn off the power supply when inserting or disconnecting the cable.
- d. Inverter should be designed carefully designed carefully to limit or stop its function when over current is detected on the on the lamp.

(6) OTHERS

- a. A strong incident light into LCD panel may cause deterioration to polarizer film, color filter, and other materials, which will degrade the quality of display characteristics. Please do not expose LCD module under strong Ultraviolet rays for a long time.
- b. Please pay attention to a panel side of LCD module not to contact with other materials in preserving it alone.
- c. For the packaging box handling, please see and obey with the packaging specification datasheet.